

# Global Potential of Concentrating Solar Power

**Franz Trieb, Christoph Schillings, Marlene O'Sullivan, Thomas Pregger, Carsten Hoyer-Klick**

Dr. Franz Trieb, German Aerospace Center, Institute of Technical Thermodynamics, Pfaffenwaldring 38-40,  
70569 Stuttgart, Germany, Phone: +49 711 6862 423, Fax: +49 711 6862 747, E-Mail: franz.trieb@dlr.de

## Abstract

The paper presents an analysis of the technical potential of concentrating solar power (CSP) on a global scale elaborated within the European project REACCESS. The analysis is based on the annual direct normal irradiation data (DNI) provided by NASA Surface Meteorology and Solar Energy program (SSE) Version 6.0. The solar resource data has been uploaded to a geographic information system and processed together with spatial data on land use, topography, hydrology, geomorphology, infrastructure, protected areas etc. excluding sites that are not technically feasible for the construction of concentrating solar power plants. The result yields a global map of DNI on land area that is potentially suited for the placement of CSP plants.

This map has been analyzed statistically using a simple CSP performance model that takes contemporary parabolic trough technology as reference to determine the potential of solar electricity generation for different classes of annual DNI intensity ranging from 2000 to 2800 kWh/m<sup>2</sup>/y. The paper describes the assessment methodology and the technical and economic CSP model, and shows the results of this analysis for the different world regions.

Keywords: concentrating solar power, solar energy resource assessment, direct normal irradiation, solar radiation atlas, cost model, performance model

## 1. Introduction

The project "Risk of Energy Availability: Common Corridors for European Supply Security" (REACCESS) under the European Commission Grant Agreement No.212011 evaluates technical, economical and environmental characteristics of present and future energy corridors within and among Europe and the supplying regions of the World, taking into account the different types of infrastructures and technologies like railways, pipelines, cables, terminals, ships and other carriers, the flows and the distances involved for oil, natural gas, coal, electricity, uranium, biomass and hydrogen [10]. The Department of Systems Analysis and Technology Assessment of the German Aerospace Center (DLR) developed a simplified performance and cost model representing CSP technology as an element of future European energy supply. It includes external supply corridors like solar electricity imports by high voltage cables from CSP plants and provides a comprehensive solar energy resource atlas on a global scale that will be described in the following.

## 2. Assessment of Solar Energy and Land Resources

A world wide data set of direct normal irradiation is available from the NASA Surface Meteorology and Solar Energy Program (SSE) Version 6.0. It is based on 22 years of data and has a spatial resolution of about 100 km, which is considered sufficient to assess the potential of CSP plants on a global scale (Figure 1). The accuracy of the data is described on the SSE website [6].

Site exclusion criteria for CSP plants were applied world wide yielding a global exclusion map shown in Figure 2. The methodology of site exclusion was described in [4]. Exclusion criteria comprise: slope > 2.1 %, land cover like permanent or non-permanent water, forests, swamps, agricultural areas, shifting sands including a security margin of 10 km, salt pans, glaciers, settlements, airports, oil or gas fields, mines, quarries, desalination plants, protected areas and restricted areas. Spatial resolution of the data was 1 km<sup>2</sup>.

Both maps were combined to yield a global map of annual direct normal irradiance for potential CSP sites

(Figure 3). This map was subdivided according to the world regions defined within the REACCESS project, and a statistical analysis of the distribution of DNI intensity classes with values higher than 2000 kWh/m<sup>2</sup>/y was made for each region, yielding the land area available for CSP classified by DNI intensities (Table 1).

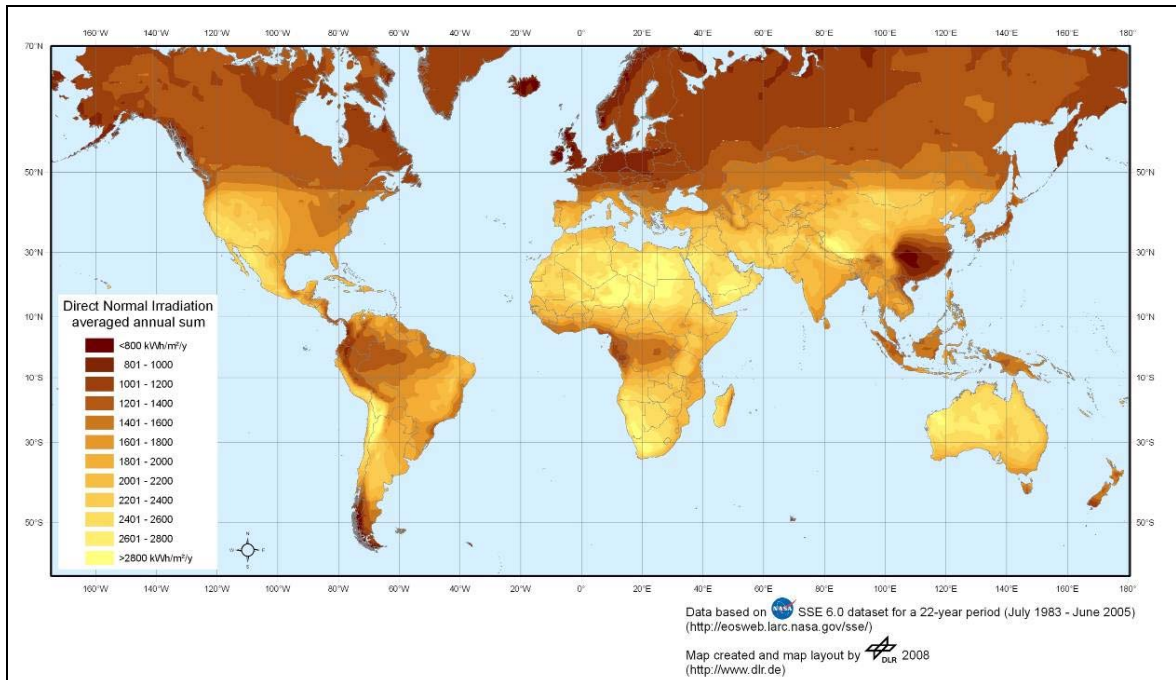

**Fig. 1. World wide annual direct normal irradiation in kWh/m<sup>2</sup>/y from NASA SSE 6.0**  
<http://eosweb.larc.nasa.gov/sse/> (picture by DLR)

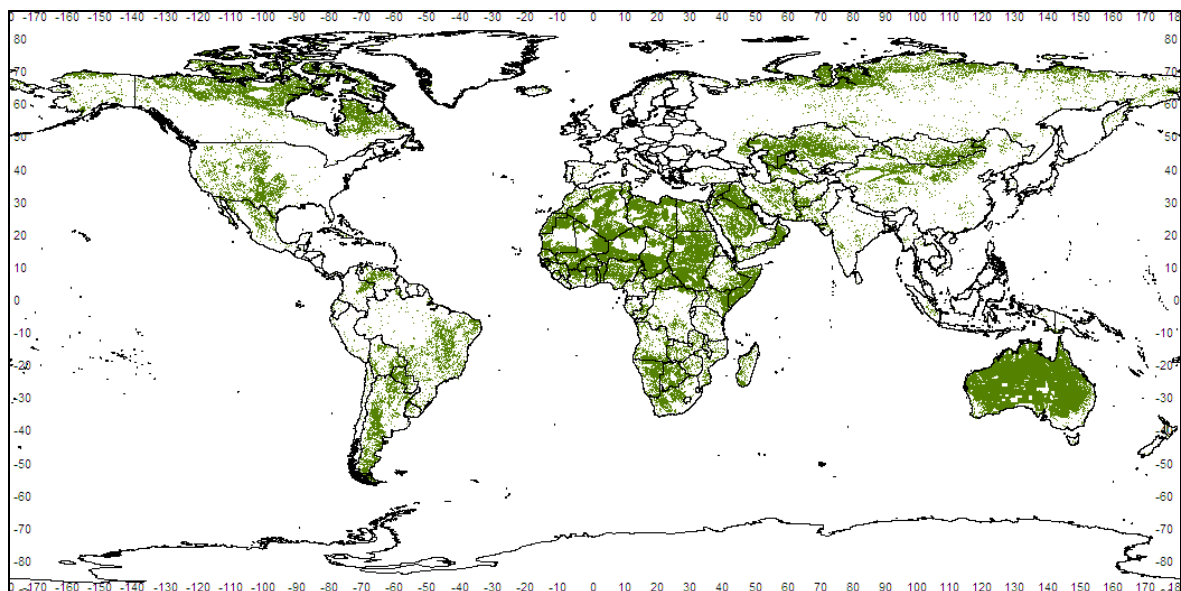

**Fig. 2. World wide exclusion of sites for CSP plant construction. Dark areas indicate suitable sites**  
**from the point of view of land suitability**

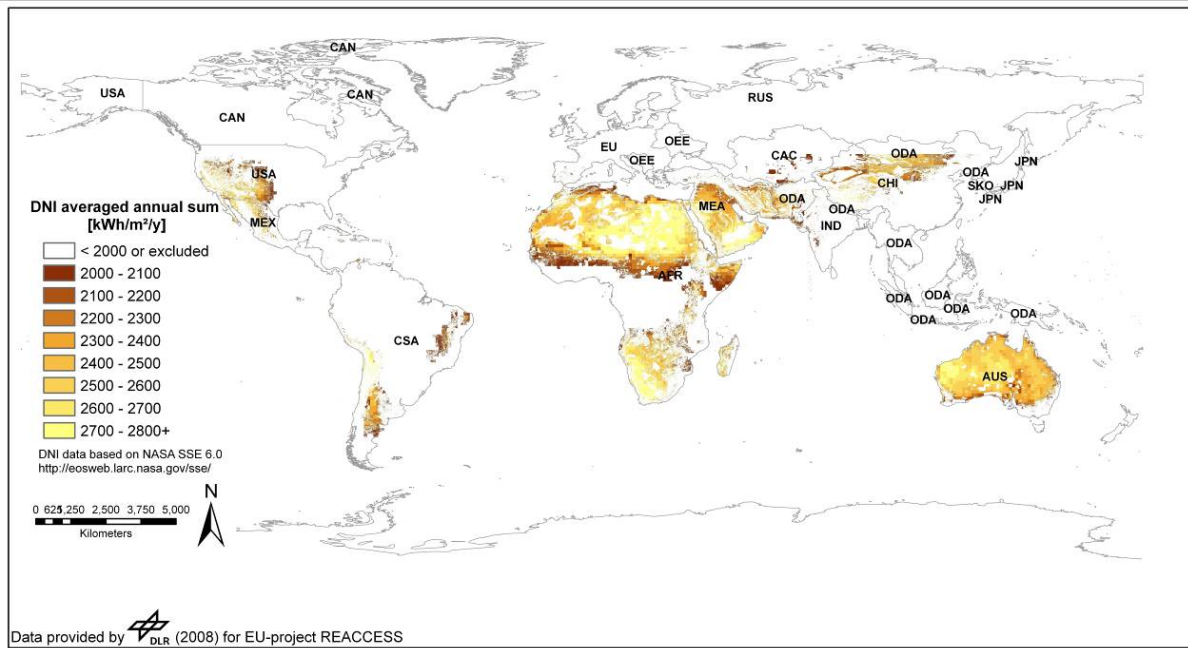

**Fig. 3. Resulting map of the annual sum of direct normal irradiation for potential global CSP sites as identified within the EU-project REACCESS. For the definition of world regions (abbreviations) and quantification of site potentials please refer to Table 1**

DNI Class kWh/m <sup>2</sup> /y	Africa km <sup>2</sup>	Australia km <sup>2</sup>	Central Asia, Caucase km <sup>2</sup>	Canada km <sup>2</sup>	China km <sup>2</sup>	Central South America km <sup>2</sup>	India km <sup>2</sup>	Japan km <sup>2</sup>
2000-2099	1,082,050	70,164	151,109		88,171	334,096	83,522	
2100-2199	1,395,900	187,746	3,025		184,605	207,927	11,510	
2200-2299	1,351,050	355,188	3,594		415,720	232,678	5,310	
2300-2399	1,306,170	812,512	1,642		263,104	191,767	7,169	
2400-2499	1,862,850	1,315,560	569		99,528	57,041	3,783	
2500-2599	1,743,270	1,775,670			96,836	31,434	107	
2600-2699	1,468,970	1,172,760			17,939	42,139	976	
2700-2800+	2,746,100	393,850			24,435	93,865	120	
<b>Total [km<sup>2</sup>]</b>	<b>12,956,360</b>	<b>6,083,450</b>	<b>159,939</b>	<b>0</b>	<b>1,190,338</b>	<b>1,190,948</b>	<b>112,497</b>	<b>0</b>

DNI Class kWh/m <sup>2</sup> /y	Middle East km <sup>2</sup>	Mexico km <sup>2</sup>	Other Developing Asia km <sup>2</sup>	Other East Europe km <sup>2</sup>	Russia km <sup>2</sup>	South Korea km <sup>2</sup>	EU27+ km <sup>2</sup>	USA km <sup>2</sup>
2000-2099	36,315	16,999	47,520	59			9,163	149,166
2100-2199	125,682	34,123	52,262	129			5,016	172,865
2200-2299	378,654	35,263	105,768	23			6,381	210,128
2300-2399	557,299	53,765	284,963				1,498	151,870
2400-2499	633,994	139,455	172,043				800	212,467
2500-2599	298,755	60,972	37,855				591	69,364
2600-2699	265,541	12,628	2,084				257	19,144
2700-2800+	292,408	14,903	1,082				270	
<b>Total [km<sup>2</sup>]</b>	<b>2,588,648</b>	<b>368,108</b>	<b>703,577</b>	<b>211</b>	<b>0</b>	<b>0</b>	<b>23,975</b>	<b>985,005</b>

**Table 1. Areas for CSP generation [km<sup>2</sup>] in the REACCESS world regions classified by DNI**

The analysis shows that most world regions except Canada, Japan, Russia and South Korea have significant potential areas for CSP at an annual solar irradiance higher than 2000 kWh/m<sup>2</sup>/y. Africa, Australia and the Middle East have the largest potential areas, followed by China and Central & South America.

### 3. CSP Performance Model

Today, CSP plants without thermal energy storage at sites with annual DNI higher than 2000 kWh/m<sup>2</sup>/y would have capacity factors of around 20-25 %, equivalent to about 2000 full load operating hours per year, with the perspective to expand their time of solar operation to base load using thermal energy storage and larger collector fields. In order to describe the capability of CSP for providing base, intermediate or peaking power, we have developed a simple model of the achievable annual full load operating hours in solar operation mode as function of plant configuration.

The configuration of a CSP plant is best described by the so called Solar Multiple (SM). For example a steam cycle power station with SM1 has one solar field just large enough to provide nominal turbine capacity under nominal irradiation conditions, e.g. at 800 W/m<sup>2</sup> on the collector aperture area. A CSP plant with a solar multiple SM2 would have a solar field twice as large and a thermal energy storage system large enough to store the energy produced by the second solar field during the day (Figure 4). Thus, one solar field will directly drive the turbine, while the other solar field will serve to fill the storage for night time operation. Storage capacity and collector field size can be increased to SM3 and SM4. Increasing solar fields further does not make sense, as during high irradiation periods they would increasingly produce unused surplus energy [2], [12].

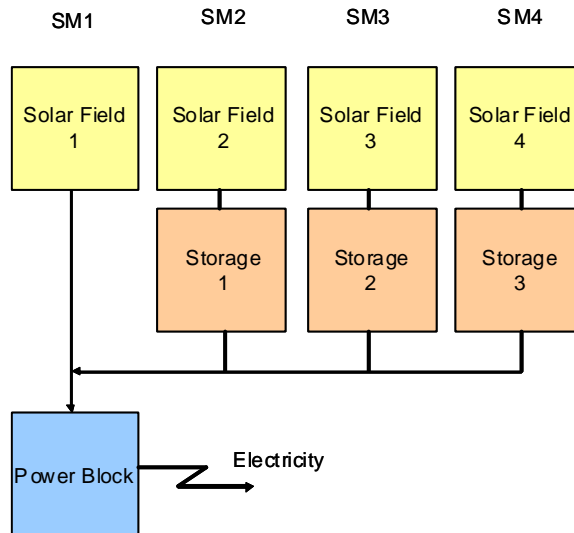

**Fig. 4. Definition of CSP plant configuration with different Solar Multiple (SM)**

In our model, a Solar Multiple of one (SM1) defines a collector field with an aperture area of 6000 m<sup>2</sup> per installed MW of power capacity. Each storage unit has a capacity of 6 full load operating hours. This model considers as reference current parabolic trough technology with molten salt storage, steam cycle power block and dry cooling tower with an annual net solar electric efficiency of about 12%.

Annual full load hours are shown in Table 2 and Figure 5 for varying configuration, latitude and annual solar irradiation. As an example, a CSP plant with a Solar Multiple 4 would have 4 x 6000 = 24000 m<sup>2</sup>/MW solar field aperture area plus 3 x 6 = 18 hours of storage capacity. Such a plant would achieve about 5900 full load operating hours at 2000 kWh/m<sup>2</sup>/y of annual solar irradiation in Southern Spain (Latitude 35°) and 8000 full load hours at a site in Southern Egypt (Latitude 25°) with 2800 kWh/m<sup>2</sup>/y annual solar irradiation.

The following simplified function was derived from this analysis. It describes the performance of different CSP plant configurations under different irradiation conditions. It gives the achievable annual full load operating hours (Flh) of a CSP plant as function of the solar multiple (SM) and annual DNI:

$$Flh = (2.5717 \cdot DNI - 694) \cdot (-0.0371 \cdot SM^2 + 0.4171 \cdot SM - 0.0744)$$

Dependence on latitude has been neglected here. Figure 6 shows the results of this simplified model. Comparison with Table 2 and Figure 5 shows a good approximation for sites between 25° and 35° latitude and typical differences of  $\pm 10\%$  for 0° latitude (underestimation) and for 40° latitude (overestimation), respectively. The simplified model does not consider possible differences of climate or latitude between sites with similar annual DNI, or performance differences between different CSP technologies and configurations [5]. However, it can be useful to give a general performance estimate of CSP technology as required by the REACCESS project, in order to characterize this technology as an element of modelling the energy sectors of different world regions, and to estimate the performance of possible future solar electricity import corridors from North Africa to Europe.

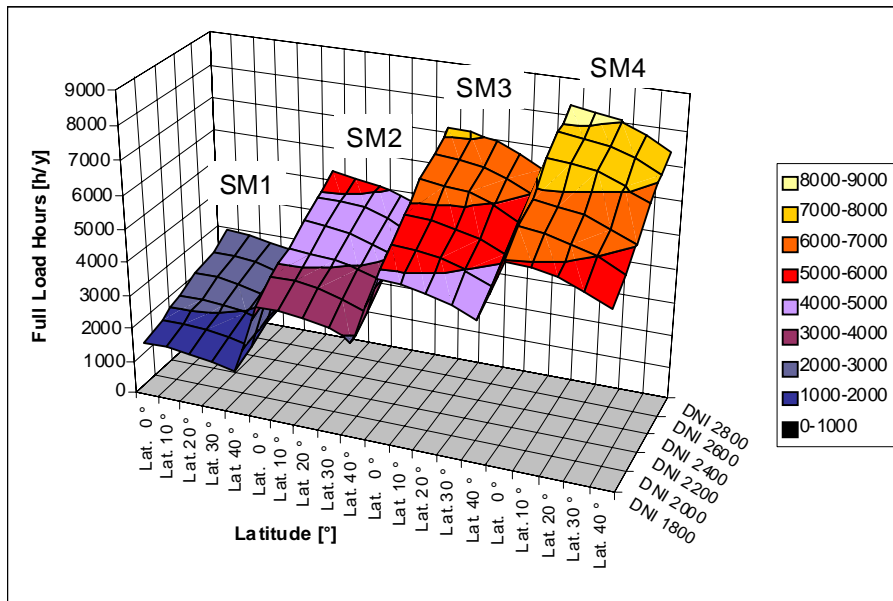

Fig. 5. Model results (annual full load hours) for varying SM, DNI and Latitude

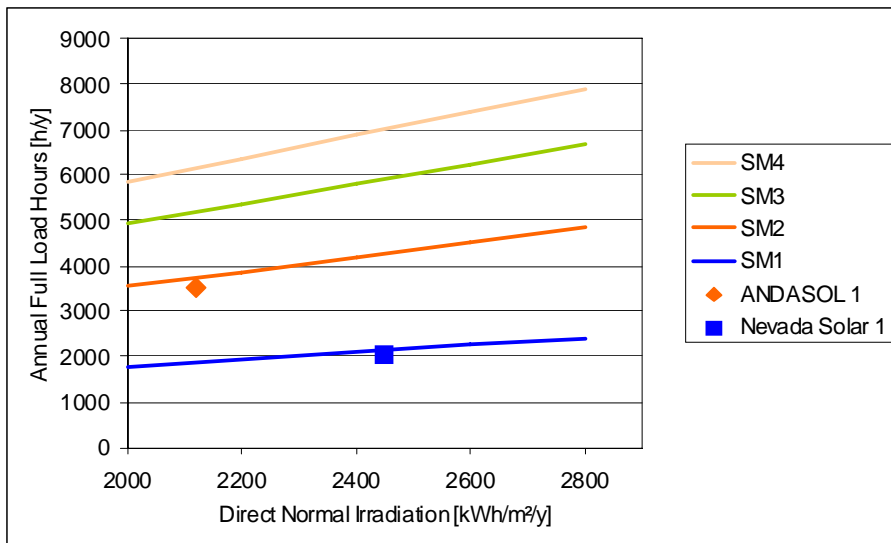

Fig. 6. Simplified model of annual solar full load hours of a CSP plant (h/y) as function of annual direct normal irradiation and solar multiple (SM) compared to reported data from recent projects ANDASOL 1 [7] and Nevada Solar 1 [1]

SM1	DNI 1800	DNI 2000	DNI 2200	DNI 2400	DNI 2600	DNI 2800
Lat. 0 °	1613	1869	2128	2362	2594	2835
Lat. 10 °	1607	1859	2130	2344	2581	2808
Lat. 20 °	1559	1801	2082	2269	2502	2725
Lat. 30 °	1460	1689	1977	2128	2350	2580
Lat. 40 °	1310	1524	1815	1920	2127	2366

SM2	DNI 1800	DNI 2000	DNI 2200	DNI 2400	DNI 2600	DNI 2800
Lat. 0 °	3425	3855	4221	4645	4931	5285
Lat. 10 °	3401	3817	4187	4612	4909	5222
Lat. 20 °	3310	3719	4098	4495	4810	5096
Lat. 30 °	3147	3539	3943	4283	4605	4887
Lat. 40 °	2911	3285	3719	3984	4301	4604

SM3	DNI 1800	DNI 2000	DNI 2200	DNI 2400	DNI 2600	DNI 2800
Lat. 0 °	4869	5414	5810	6405	6713	7147
Lat. 10 °	4829	5358	5752	6365	6690	7074
Lat. 20 °	4711	5223	5630	6229	6583	6929
Lat. 30 °	4499	4995	5434	5970	6352	6676
Lat. 40 °	4189	4674	5163	5601	5987	6322

SM4	DNI 1800	DNI 2000	DNI 2200	DNI 2400	DNI 2600	DNI 2800
Lat. 0 °	5987	6520	6796	7563	7859	8243
Lat. 10 °	5918	6430	6711	7514	7831	8160
Lat. 20 °	5761	6260	6563	7380	7724	8009
Lat. 30 °	5506	5999	6340	7110	7497	7738
Lat. 40 °	5155	5650	6045	6717	7115	7348

**Table 2. Annual full load hours (h/y) of CSP plants for different Solar Multiple (SM), different annual direct normal irradiation (DNI) and different latitudes (Lat.) from hourly time series modeling**

#### 4. CSP Cost Model

The cost of concentrating solar power plants was modeled as function of time individually for the different components of such plants. For each component, a separate learning curve and progress ratio for future cost development was assumed (Table 5). The learning curve of each component – investment cost ( $c$ ) as function of time ( $x$ ) – was calculated from the total installed capacity ( $P$ ) and from the progress ratio ( $PR$ ) according to the following equation, where ( $P_0$ ) was the installed capacity at the starting year (2005) and  $P_x$  was the installed capacity in the year  $x$ , and  $c_0$  and  $c_x$  stand for the respective specific investment at that time [3], [8]:

$$c_x = c_0 \cdot \left( \frac{P_x}{P_0} \right)^{\frac{\log PR}{\log 2}}$$

A progress ratio of 90% means that the specific investment is reduced by 10% each time the world wide installed capacity doubles. The model was based on a scenario of world wide CSP expansion considered as realistic. It starts with 354 MW solar power capacity installed in 2005 and expands to 5,000 MW by 2015, 150,000 MW by 2030 and 500,000 MW by 2050 (see also [11], [15]). According to this expansion and the learning rates assumed here, the specific investment cost of CSP plants would develop as shown in Figure 7 for different plant configurations with varying solar multiple and solar operating hours (SM1 - SM4). For REACCESS, a solar multiple of SM4 has been taken as reference for performance and cost modeling. The CSP cost model considers current oil-cooled parabolic trough technology with molten salt storage and steam cycle power block with dry cooling tower as reference.

Taking into account the annual full load operating hours from Figure 6 and the related investment learning curve for a solar multiple of SM4 from Figure 7, it is possible to calculate the total electricity cost as function of solar irradiation and time (Figure 8 and Table 7). The model assumes constant (real) monetary value of

€<sub>2005</sub>, a real discount rate of 6%, economic plant lifetime of 25 years, an annual operation and maintenance cost rate of 2% of the investment, an annual insurance rate of 0.5% of the investment, as well as the learning rates and achievable annual full load hours as described before.

In Figure 8 the cost of CSP has been compared to the cost of electricity produced by fossil fuels as calculated by [9]. The energy-economic model and the parameters used by Nitsch were the same as used in our model above. The comparison shows that CSP can become fully competitive between 2020 and 2030, and can later contribute significantly to stabilize global electricity costs. As the capacity needed to achieve this cost reduction is rather high, the expansion of CSP (like other renewables) can be considered a preventive measure against electricity cost escalation and climate change.

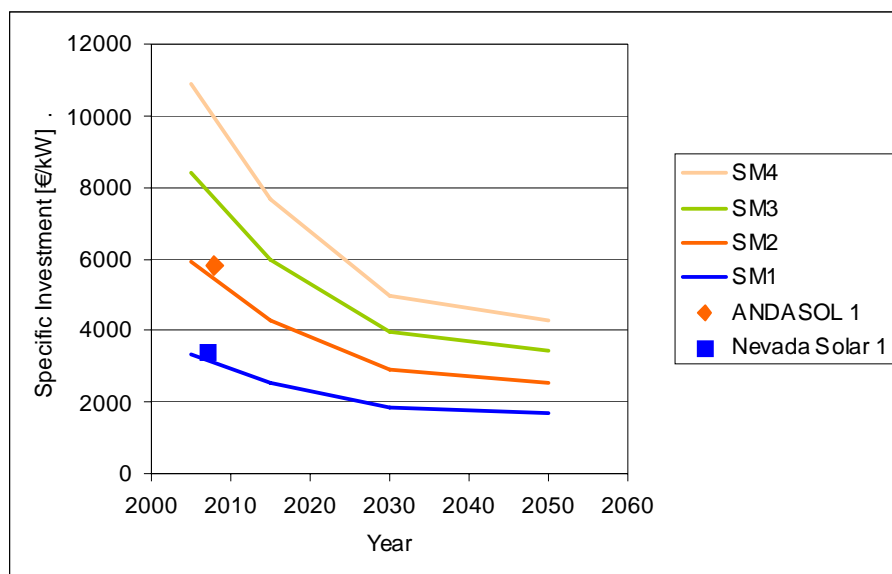

**Fig. 7. Learning curves for the investment of CSP plants as function of the Solar Multiple and time including example data from ANDASOL 1 [7] and Nevada Solar 1 [1]**

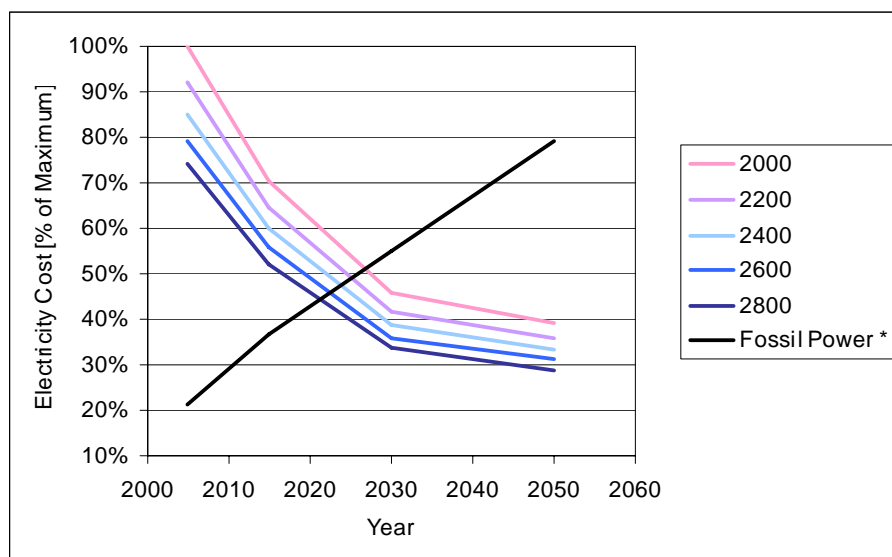

**Fig. 8. Electricity cost in % of the maximum starting value in 2005 as function of time and direct normal irradiation (DNI in kWh/m²/y) for CSP reference plants with a solar multiple SM4 compared to the cost of power generation from fossil fuels (including carbon costs) according to [9]\***

## 5. Global CSP Potential

The following definitions were used to calculate the solar-to-electricity efficiency of concentrating solar power stations with respect to the total land area required:

$$\text{Solar Electric Efficiency} = \frac{\text{Annual Net Power Generation}}{\text{Annual Direct Irradiance on Aperture}}$$

$$\text{Land Use Factor} = \frac{\text{Aperture Area of Reflectors}}{\text{Total Land Area Required}}$$

$$\text{Land Use Efficiency} = \text{Solar Electric Efficiency} \times \text{Land Use Factor}$$

In our model, we have taken a typical parabolic trough steam cycle power station with thermal energy storage as reference for assessing the solar-to-electricity conversion efficiency. With respect to the aperture area, a parabolic trough system with wet cooling tower would have an average annual efficiency of 15%. Assuming the preferred employment of dry-cooling towers in desert areas and increased parasitic losses for storage and larger collector fields, the overall efficiency is reduced in our model to about 12%. That means that 12% of the solar irradiation on the reflector aperture area of a parabolic trough collector can be transformed to net electricity delivered to the grid. With respect to the total required land surface, a parabolic trough collector field typically covers about 37% of the land area (Figure 9, Table 3). The overall land use efficiency therefore results to 4.5% (12% times 37%) which describes the yield of a typical parabolic trough power station with respect to the solar energy irradiated per year on the total land surface required by the plant.

In order to calculate the technical CSP electricity potential world wide, land areas available for CSP plant erection from Table 1 were multiplied with a land use efficiency of 4.5% derived above. This simple approach yields a good estimate of the technical potential of CSP represented by the well proven parabolic trough technology (Table 4). The analysis yields a total global CSP potential of 2,945,926 TWh/y. By comparing this number to the present world electricity consumption of less than 18,000 TWh/y it becomes apparent that the available technical CSP potential could theoretically cover this demand manifold. The location of this potential is concentrated mainly in the desert regions of the world as can be seen in Figure 3.

Collector & Power Cycle Technology	Solar-Electric Aperture Related Efficiency	Land Use Factor	Land Use Efficiency
Parabolic Trough Steam Cycle	11 - 16%	25 - 40%	3.5 - 5.6%
Central Receiver Steam Cycle	12 - 16%	20 - 25%	2.5 - 4.0%
Linear Fresnel Steam Cycle	8 - 12%	60 - 80%	4.8 - 9.6%
Central Receiver Combined Cycle*	20 - 25%	20 - 25%	4.0 - 6.3%
Multi-Tower Solar Array Steam or Combined Cycle*	15 - 25%	60 - 80%	9.0 - 20.0%

\* future concepts

**Table 3. Solar-electric efficiency, land use factor and land use efficiency of different CSP technologies. A parabolic trough system with 12% annual solar-electric efficiency, 37% land use factor and 4.5% land use efficiency was taken as reference.**



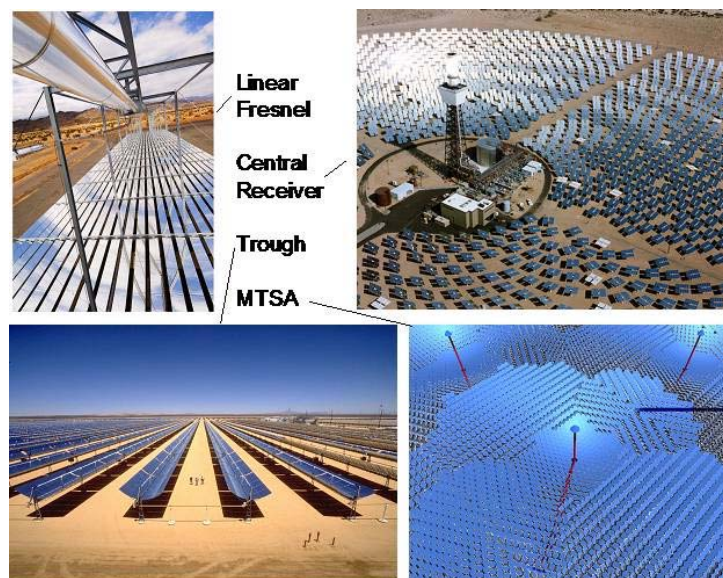

**Fig. 9. Land use of different concentrating solar collector concepts. Multi-Tower Solar Array MTSA shows an artist view of a potential future central receiver concept with very high land use efficiency**

DNI Class kWh/m <sup>2</sup> /y	Africa TWh/y	Australia TWh/y	Central Asia, Caucase TWh/y	Canada TWh/y	China TWh/y	Central South America TWh/y	India TWh/y	Japan TWh/y
2000-2099	102,254	6,631	14,280	0	8,332	31,572	7,893	0
2100-2199	138,194	18,587	300	0	18,276	20,585	1,140	0
2200-2299	139,834	36,762	372	0	43,027	24,082	550	0
2300-2399	141,066	87,751	177	0	28,415	20,711	774	0
2400-2499	209,571	148,001	64	0	11,197	6,417	426	0
2500-2599	203,963	207,753	0	0	11,330	3,678	13	0
2600-2699	178,480	142,490	0	0	2,180	5,120	119	0
2700-2800+	346,009	49,625	0	0	3,079	11,827	15	0
<b>Total [TWh/y]</b>	<b>1,459,370</b>	<b>697,600</b>	<b>15,193</b>	<b>0</b>	<b>125,835</b>	<b>123,992</b>	<b>10,928</b>	<b>0</b>

DNI Class kWh/m <sup>2</sup> /y	Middle East TWh/y	Mexico TWh/y	Other Developing Asia TWh/y	Other East Europe TWh/y	Russia TWh/y	South Korea TWh/y	EU27+ TWh/y	USA TWh/y
2000-2099	3,432	1,606	4,491	6	0	0	866	14,096
2100-2199	12,443	3,378	5,174	13	0	0	497	17,114
2200-2299	39,191	3,650	10,947	2	0	0	660	21,748
2300-2399	60,188	5,807	30,776	0	0	0	162	16,402
2400-2499	71,324	15,689	19,355	0	0	0	90	23,903
2500-2599	34,954	7,134	4,429	0	0	0	69	8,116
2600-2699	32,263	1,534	253	0	0	0	31	2,326
2700-2800+	36,843	1,878	136	0	0	0	34	0
<b>Total [TWh/y]</b>	<b>290,639</b>	<b>40,675</b>	<b>75,561</b>	<b>21</b>	<b>0</b>	<b>0</b>	<b>2,409</b>	<b>103,704</b>

**Table 4. Technical CSP potential in TWh/y in the REACCESS world regions classified by DNI**

A comparison of Table 4 with Table 2 allows for an estimate of the annual full load hours and of the electricity cost valid for the amount of electricity that could be generated in each region and within each class of direct normal irradiation intensity. On the basis of this information, the project REACCESS will evaluate the feasibility, cost and performance of CSP plants in the Middle East and North Africa and assess electricity imports to Europe based on the approach described in [13], [14]. The results of this analysis will be published elsewhere. This approach can also be applied to other regions of the world with similar conditions and resources.

## 6. Conclusions

The global technical potential of concentrating solar power amounts to almost 3,000,000 TWh/y, a number considerably larger than the present world electricity consumption of 18,000 TWh/y. The low resolution DNI data and the simplified modeling of CSP performance used here is acceptable for the assessment of global potentials and for a first estimate of CSP performance under varying conditions, but is not considered sufficiently accurate for project development. Immense solar energy resources are concentrated in the deserts of the earth. Under desert conditions, CSP plants with large solar fields and thermal energy storage are in principle capable of producing base load electricity at full capacity for up to 8000 hours per year. While the cost of such systems is still high today, such plants can become a competitive option of electricity supply in the medium term, if an optimistic/realistic expansion of this technology – which can already be perceived today – takes place. The distribution of potential areas for CSP world wide has been mapped with high spatial resolution. It confirms the possibility of applying the concept of solar electricity transfer from deserts to be applicable to many regions of the world. Solar electricity imports from deserts and semi-deserts to large centers of demand can help to reduce greenhouse gas emissions and to stabilize electricity costs all over the world, as they can deliver both base load electricity and balancing power.

Year	PR	2005	2015	2030	2050	Unit
World CSP Capacity		354	5000	150000	500000	MW
Solar Field	90%	360	241	144	120	€/m <sup>2</sup>
Power Block	98%	1200	1111	1006	971	€/kW
Storage	92%	60	44	29	25	€/kWh

**Table 5. Assumed expansion of CSP capacity, start values  $c_0$  (2005), progress ratio  $PR$  and future costs of CSP plant components in €<sub>2005</sub> taking current parabolic trough technology, molten salt storage and steam cycle power block with dry cooling tower as reference**

Year	2005	2015	2030	2050
SM1	3360	2559	1869	1690
SM2	5880	4269	2907	2560
SM3	8400	5978	3944	3429
SM4	10920	7688	4982	4299

**Table 6. Total specific investment of CSP plants in €<sub>2005</sub>/kW as function of the Solar Multiple SM and time, taking into account economies of scale and world wide expansion as by Table 5. SM4 was taken as reference. Future development may include other technologies competing with parabolic troughs.**

DNI [kWh/m <sup>2</sup> /y]	2005	2015	2030	2050
2000	100%	70%	46%	39%
2200	92%	65%	42%	36%
2400	85%	60%	39%	33%
2600	79%	56%	36%	31%
2800	74%	52%	34%	29%
Fossil Power *	21%	37%	55%	79%

**Table 7. Electricity cost learning curves in % of the maximum starting value in 2005 as function of direct normal irradiation (DNI in kWh/m<sup>2</sup>/y) for CSP reference plants with a solar multiple SM4, compared to the cost of power generation by fossil fuels (including carbon costs) according to [9]\***

## Literature

- [1] Cohen, G.E., Solar Steam at Nevada Solar One, SolarPaces Conference, Las Vegas, USA, 2008
- [2] Eck, M., Rueda, F., Kronshage, S., Schillings, C., Trieb, F., Zarza, E., Solar Thermal Power Plants for the Spanish Electricity Market, Int. J. Energy Technology and Policy, Vol.5, No.3 (2007), 261-270
- [3] ECOSTAR 2005: Pitz-Paal, R., Dersch, J., Milow, B., European Concentrated Solar Thermal Road Mapping, ECOSTAR, SES6-CT-2003-502578, European Commission, 6th Framework Programme, German Aerospace Center, Cologne 2005 [ftp://ftp.dlr.de/ecostar/ECOSTAR\\_Roadmap2005.pdf](ftp://ftp.dlr.de/ecostar/ECOSTAR_Roadmap2005.pdf)
- [4] MED-CSP 2005: Trieb, F., Schillings, C., Kronshage, S., Viebahn, P., May, N., Paul, C., Klann, U., Kabariti, M., Bennouna, A., Nokraschy, H., Hassan, S., Georgy Youssef, L., Hasni, T., Bassam, N., Satoguina, H., Concentrating Solar Power for the Mediterranean Region (MED-CSP), Internet Publication of Final Report, German Aerospace Center (DLR), Study for the German Ministry of Environment, Nature Conservation and Nuclear Safety, Stuttgart 2005, [www.dlr.de/tt/med-csp](http://www.dlr.de/tt/med-csp)
- [5] Müller-Steinhagen, H., Trieb, F., Concentrating Solar Power for Sustainable Electricity Generation- Part 1: Technology Review, ingenia, Royal Academy of Engineering, No. 18, (2004), 43-50
- [6] NASA 2008: Surface meteorology and Solar Energy, A renewable energy resource web site (release 6.0) sponsored by NASA's Earth Science Enterprise Program <http://eosweb.larc.nasa.gov/sse/>
- [7] Nebrera, J. A., Solar Thermal Power Generation - A Spanish Success Story, Feria Internacional de Energia y Medio Ambiente (genera08), Madrid, February 2008
- [8] Neij, L., Experience Curves: A Tool for Energy Policy Assessment, Lund University, European Commission, Lund 2003, [http://www.iset.uni-kassel.de/extool/Extool\\_final\\_report.pdf](http://www.iset.uni-kassel.de/extool/Extool_final_report.pdf)
- [9] Nitsch, J., Lead Study 2008: Further development of the 'Strategy to increase the use of renewable energies' within the context of the current climate protection goals of Germany and Europe; Study commissioned by the German Federal Ministry for the Environment, Nature Conservation and Nuclear Safety (BMU), Berlin 2008 [http://www.bmu.de/english/renewable\\_energy/downloads/doc/42726.php](http://www.bmu.de/english/renewable_energy/downloads/doc/42726.php)
- [10] REACCESS 2008: Risk of Energy Availability: Common Corridors for Europe Supply Security, European Commission Grant Agreement No.212011, <http://reaccess.epu.ntua.gr/>
- [11] Richter, C., Teske, S., Nebrera, J.A., Concentrating Solar Power – Global Outlook 2009, Greenpeace, SolarPaces and ESTELA 2009
- [12] Tamme, R., Steinmann, W.D., Laing, D., 2004: High temperature thermal energy storage technologies for parabolic trough. J. Solar Energy Eng., 126 (2) (2004) 794–800
- [13] TRANS-CSP 2006: Trieb, F., Schillings, C., Kronshage, S., Viebahn, P., May, N., Paul, C., Klann, U., Kabariti, M., Bennouna, A., Nokraschy, H., Hassan, S., Georgy Youssef, L., Hasni, T., Bassam, N., Satoguina, H., Trans-Mediterranean Interconnection for Concentrating Solar Power (TRANS-CSP), Internet Publication of Final Report, German Aerospace Center (DLR), Study for the German Ministry of Environment, Nature Conservation and Nuclear Safety, Stuttgart 2006, [www.dlr.de/tt/trans-csp](http://www.dlr.de/tt/trans-csp)
- [14] Trieb, F., Müller-Steinhagen, H., Europe-Middle East-North Africa Cooperation for Sustainable Electricity and Water, Sustainability Science Vol.2, No.2 (2007), 205-219
- [15] Viebahn Peter; Kronshage, Stefan; Trieb Franz; Lechon Yolanda (2008): Final Report on Technical Data, Costs, and Life Cycle Inventories of Solar Thermal Power Plants. Deliverable 12.2 – RS I a of EU IP-NEEDS. [www.needs-project.org](http://www.needs-project.org)

**Acknowledgement:** We thank Paul Stackhouse from NASA Langley Research Center for providing the NASA SSE 6.0 dataset.