

Scuola Universitaria Professionale
della Svizzera Italiana

Dipartimento
Ambiente
Costruzioni e
Design

Laboratorio
Energia
Ecologia
Economia

c.p.
CH-6952 Canobbio

Da
Telefono
E-mail

Dr. Daniel Pahud
+41 91 935 13 53
daniel.pahud@dct.supsi.ch

OGGETTO Solar heating system with seasonal heat store at Heumatt

TITOLO

**Central Solar Heating Plant with a Seasonal
Storage (CSHPSS) at Heumatt, Zürich Seebach
Analysis and design by dynamic system simulations**

COMMITTENTE ZHW – Zürcher Hochschule Winterthur
Postfach 805
CH – 8401 Winterthur

ESTENSORE RAPPORTO Dr. Daniel Pahud, SUPSI – DACD – LEEE

LUOGO E DATA Lugano/Trevano, 3 ottobre 2003
Heumatt-final-report.doc

Table of content

1. Introduction and objective of the study	3
2. System layout and control strategy	4
3. Variant “Hochhaus”	8
4. Variant “Hochhaus + Kurzhaus”	17
5. Rules of thumb for sizing the Heumatt CSHPSS.....	26
6. Optimal system design and sensitivity to some parameters.....	27
7. References.....	37

1. Introduction and objective of the study

In the Heumatt area (Zurich Seebach), three buildings of flats will be retrofitted (Hochhaus, Kurzhaus and Langhaus). In the framework of this project, a Central Solar Heating Plant with a Seasonal Storage (CSHPSS) is studied with the objective to halve the remaining heating demand.

This report gives a synthesis of the main results obtained during the course of the Heumatt CSHPSS's system analysis and study. The results are presented from the most recent to the early ones.

The main objective of the study is to establish a dynamic model the whole system and simulate the thermal performances to optimally size the main components.

The system design and control strategy is explained in chapter 2. Chapters 3 and 4 contain the CSHPSS design results and thermal performances of the variant "Hochhaus" and "Hochhaus + Kurzhaus" for a solar fraction of 50%. Thumb of rules are given in chapter 5, based on the two previous variants (chapter 3 and 4). Finally, chapter 6 presents the optimization results performed on the largest variant (Hochhaus + Kurzhaus + Langhaus). Sensitivities to some parameters are also shown.

2. System layout and control strategy

The system layout is shown in figure 2.1. All the main subsystems (the collector array, the ground store, the space heating heat distribution and the hot water distribution) are connected to the water buffer store. In this way each subsystems can be operated independently with optimum conditions. This also make the system control simpler and easier to understand and implement. For simplification, only one collector subsystem and one hot water subsystem are represented. The collector subsystem is comprised of the collector array, the solar heat exchanger, the pressure relief valve and the pump P1. The hot water subsystem is comprised of the hot water tank, the hot water heat exchanger, the two-way valve V4 and the pump P7. The collector and hot water subsystems are decentralised and several of those can be connected in parallel, depending on the number of houses or block of houses which have a collector array and a hot water subsystem. In practice, hot water is prepared at the place where it is used. The system layout corresponds to a system with a 6-pipes heat distribution network (2 for the collector arrays, 2 for space heating and 2 for hot water).

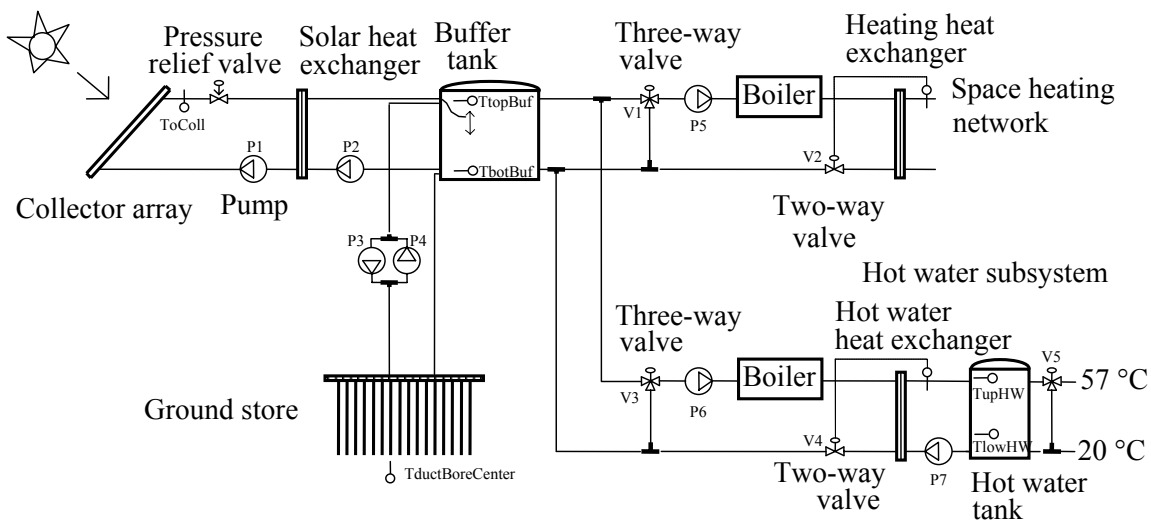

- TtopBuf: fluid temperature at the top of the buffer tank
- TbotBuf: fluid temperature at the bottom of the buffer tank
- TductBoreCenter: ground temperature in the immediate vicinity of a borehole at the centre of the ground store
- ToColl: outlet fluid temperature from the collector array
- TductIn: inlet fluid temperature in the ground heat exchanger
- TductOut: outlet fluid temperature from the ground heat exchanger
- TupHW: water temperature of the hot water tank at 70% of its height
- TlowHW: water temperature of the hot water tank at 15% of its height

Figure 2.1: Layout and temperature sensors for system control

Collector array control

An on/off controller with dead-band temperature differences controls the two pumps of the collector subsystem. Two fluid temperatures are compared. The collector fluid temperature at the outlet pipe position and the water temperature at the bottom of the buffer store are chosen. The flow rate in the collectors is set to a constant value (0.007 kg/s per m² of collector area) when available solar gains are collected. The flow rate on the buffer side of the solar heat exchanger is set to the same value when solar heat can be transferred to the buffer store. A pressure relief valve limits the outlet fluid temperature from the solar collectors to 100 °C. The pipe position of the entering water in the buffer store is variable. The pipe position is adjusted so that the local buffer store temperature and the incoming water temperature are as close as possible. In other terms, a stratified charge of the buffer store is performed.

- ON/OFF controller for the collector pumps P1 and P2:
 $TH = T_{oColl}$ $(TH - TL) > 14 \text{ K}$ \Rightarrow collector pumps P1 and P2 ON
 $TL = T_{botBuf}$ $(TH - TL) < 2 \text{ K}$ \Rightarrow collector pumps P1 and P2 OFF
- Constant flow rate for the P1 and P2 pumps:
 $flow = 0.007 \text{ (kg/m}^2\text{s)} \times COAREA \text{ (m}^2\text{)} \times 3600 \text{ (s/h)}$
 COAREA is the collector area.
- Stratified charge of the buffer store:
 variable inlet pipe position of the collector flow circuit. The fluid enters the buffer store at the level where the store temperature is the closest to the incoming fluid temperature.

Ground store control

The operation of the two ground store pumps is controlled with on/off controllers. Only one pump can be run at a time, depending on the loading or unloading operation mode of the ground store. The flow rate is adjusted to preserve as much as possible the vertical temperature stratification in the buffer store. In the loading mode, heat is transferred from the buffer store to the ground store. Water is taken at the top of the buffer store, pushed through the ground heat exchanger and re-enters at the bottom of the buffer store. In the unloading mode, the other pump is used, resulting in reverse fluid circulation. In this operation mode, heat is transferred from the ground store to the buffer store.

Ground store loading mode

Two ON/OFF controllers are used. The pump is operated only if the two controls are ON.

- First ON/OFF controller for the ground store loading pump P3:
 $TH = T_{topBuf}$ $(TH - TL) > 5 \text{ K}$ \Rightarrow ground loading pump ON
 $TL = T_{ductBoreCenter}$ $(TH - TL) < 1 \text{ K}$ \Rightarrow ground loading pump OFF
- Second ON/OFF controller for the ground store loading pump P3:
 $TH = T_{topBuf}$ $(TH - TL) > 2 \text{ K}$ \Rightarrow ground loading pump ON
 $TL = 60^\circ\text{C}$ $(TH - TL) < 0 \text{ K}$ \Rightarrow ground loading pump OFF

- Variable flow rate control
 $T_{ductOut} = T_{botBuf}$, but with the following three constraints:
 - $dT_{in-out} = T_{ductIn} - T_{ductOut} \geq 3 \text{ K}$
 - IF *flow rate* < *flow min* THEN *flow rate* = 0 kg/h (pump OFF)
 $flow \ min = 100 \text{ kg/h}$
 - IF *flow rate* > *flow max* THEN *flow rate* = *flow max*
 $flow \ max = 0.007 \text{ (kg/m}^2\text{s)} \times COAREA \text{ (m}^2\text{)} \times 3600 \text{ (s/h)}$
 COAREA: total collector area
 as a result, $T_{ductOut} \leq T_{botBuf}$ when the pump is ON.

Ground store unloading mode

Only one ON/OFF controller is used.

- ON/OFF controller for the ground store unloading pump P4
 $TH = T_{ductBoreCenter} \quad (TH - TL) > 1 \text{ K} \quad \geq \quad \text{ground unloading pump ON}$
 $TL = T_{topBuf} \quad (TH - TL) < 0 \text{ K} \quad \geq \quad \text{ground unloading pump OFF}$
- Variable flow rate control
 $T_{ductOut} = T_{topBuf}$, but with the following three constraints:
 - $dT_{out-in} = T_{ductOut} - T_{ductIn} \geq 3 \text{ K}$
 - IF *flow rate* < *flow min* THEN *flow rate* = 0 kg/h (pump OFF)
 $flow \ min = 100 \text{ kg/h}$
 - IF *flow rate* > *flow max* THEN *flow rate* = *flow max*
 $flow \ max = 0.007 \text{ (kg/m}^2\text{s)} \times COAREA \text{ (m}^2\text{)} \times 3600 \text{ (s/h)}$
 COAREA: total collector area
 as a result, $T_{ductOut} \geq T_{topBuf}$ when the pump is ON.

Heat distribution control

Space heating energy and hot water energy are delivered by two separate distribution networks which are directly connected to the buffer store. The following description is valid for each distribution network. The three-way valve permits the disconnection of the heat distribution subsystem from the solar part of the system, when the fluid temperature at the top of the buffer store is lower than the return fluid temperature from the heat exchanger. The inlet temperature on the primary side of the heat exchanger can not fall below a value which is shifted by some Kelvins (set to 5K) relative to the requested outlet fluid temperature on the secondary side. If necessary, the boiler is used to raise the fluid temperature to the desired value. The heat exchanger is a counter-flow heat exchanger whose UA-value depends on the maximum heat rate to be transferred and also on the above mentioned temperature shift. The two-way valve, controlled by the forward fluid temperature on the secondary side of the heat exchanger, reduces the flow rate on the primary side as much as possible, thus making the lowest return fluid temperature to the buffer store possible. The maximum flow rate on the primary side of the heat exchanger must be greater than the maximum value on the secondary side. The pump is switched off if the heat demand is null.

Space heating heat distribution

- Space heating boiler
If necessary, the boiler raises the incoming fluid temperature from pump P5 to $(T_{set} + 5K)$. T_{set} is the desired forward fluid temperature in the space heating distribution network. T_{set} depend on the outdoor air temperature.
- Space heating flow rate control on the primary side
The flow rate is adjusted by the two-way valve so that the forward fluid temperature in the distribution network corresponds to T_{set} .

Hot water heat distribution

- Hot water boiler
If necessary, the boiler raises the incoming fluid temperature from pump P6 to $(57\text{ °C} + 5K = 62\text{ °C})$.

Each hot water subsystem comprises a hot water heat exchanger, a hot water tank, a pump (P7), a two-way valve (V4) and a three-way valve (V5). This latter ensures that the distributed hot water temperature does not exceed 57 °C . It could be avoided in practice, as the water temperature in the hot water tank is already controlled (58 °C). Only one hot water subsystem is simulated.

- Variable flow rate control on the primary side
The flow rate is adjusted by the two-way valve (V4) so that the outlet fluid temperature on the secondary side of the heat exchanger is equal to 58 °C .
- Flow rate control on the secondary side (pump P7)
The flow rate may have two values. The low value corresponds, with a temperature difference of hot and cold water of $37K$ ($57\text{ °C} - 20\text{ °C}$), to the average heat rate required for the heating of hot water during the year. The high flow rate value is set to twice the low value.

The flow rate is controlled by two temperature sensors in the hot water tank (T_{upHW} and T_{lowHW}). T_{upHW} and T_{lowHW} are water temperatures measured at respectively 70% and 15% of the tank height.

The flow rate control is performed as shown in figure 2.2.

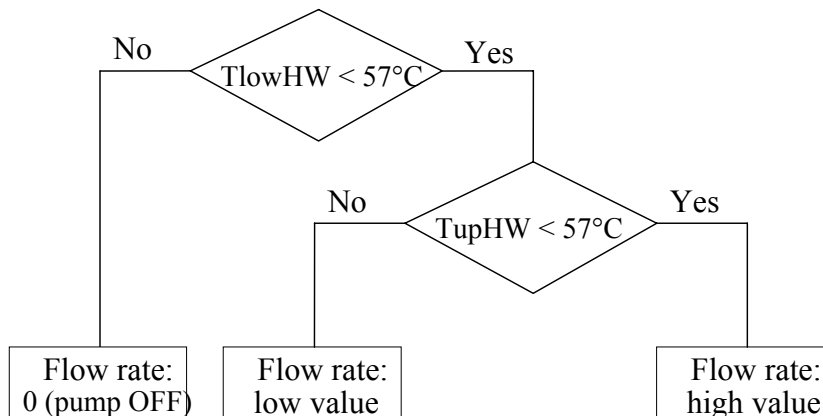

Figure 2.2: Schematic presentation of the procedure followed for the control of the pump P7

3. Variant “Hochhaus”

The CSHPSS is designed for the “Hochhaus” alone. The annual heating demand amounts to only **406 MWh/year** (64% space heating and 36% domestic hot water). The buffer store volume has an optimal value if comprised between 60 to 100 litres per square meter of collector area (see chapter 6). A value of 80 litre/m² is fixed. Losses in the collector array pipe connections is taken into account with an additional value added to the collector loss factor. Losses in the distribution system are estimated to be 1% of the annual heat distributed and is included in the heat load. The pipe connection losses between the buffer water store and the seasonal ground store are simulated with two pipe components. All the system parameters are listed at the end of this chapter. An optimal system that fulfill the following conditions is simulated.

OPTIMUM DESIGN REQUIREMENTS

The optimum system dimensions have to meet the following requirements:

- Solar fraction of at least 50%
- Maximum inlet fluid temperature in buffer store < 95 °C
- Maximum ground temperature in the centre part of the ground store < 75°C

The pipe arrangement in the ground store is rectangular and fixed to 0.35 x 0.7m. With this setting, the second conditions is always met if the third one is met. The third condition is necessary for a long life time of the pipes in the ground store. It imposes a minimum ground store volume to be fulfilled. It is also an advantage for the collector array which will never overheat during normal operation.

COST DATA

SUBSYSTEM COST	Parameter value
Solar collectors	610 CHF/m ²
Buffer store	710 CHF/m ³
Ground store	120 CHF/m ³

Annuity factor for collector subsystem: **0.10** (life time of 25 years)

Annuity factor for the two storages: **0.09** (life time of 40 years)

PARAMETER VARIATION

The scaling factor for the parameter variation is the collector area.

- collector area (absorber area): 700 – 800 – 900 m²
- ground store: 4 – 4.5 – 5 m³/m²

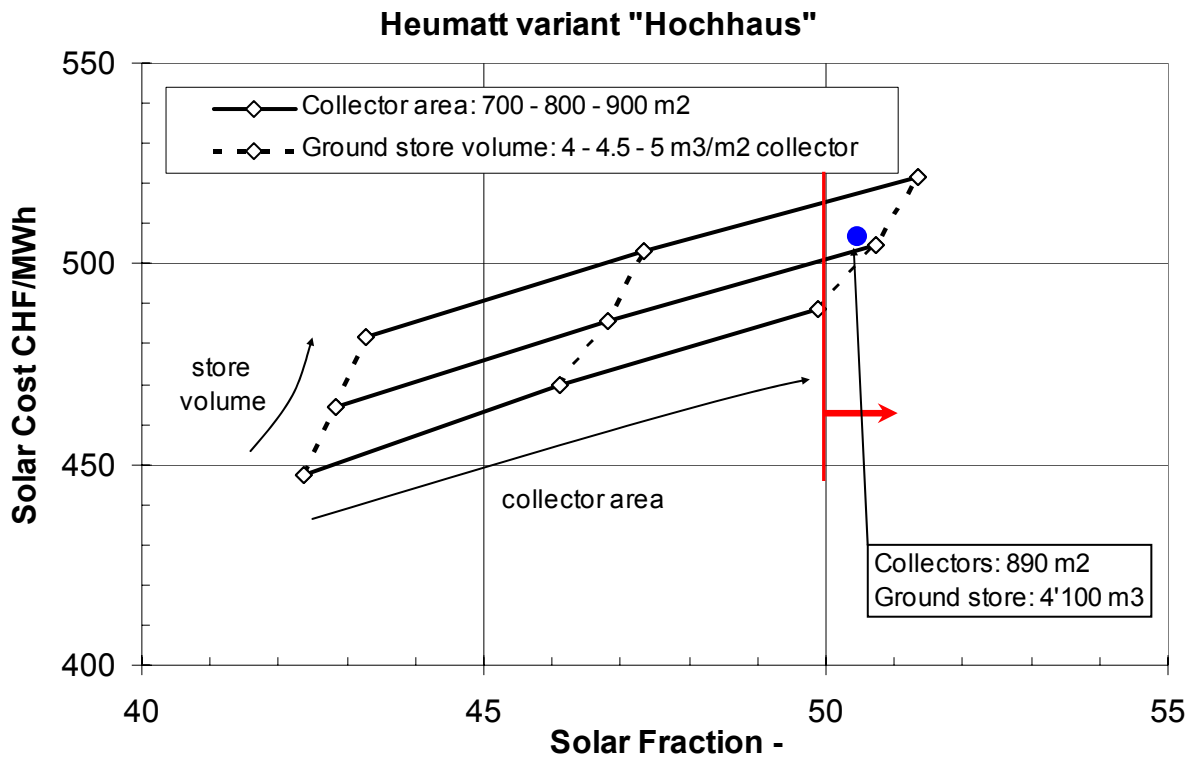

Figure 3.1: Solar cost of the simulated systems in relation to the solar fraction for the "Hochhaus" variant

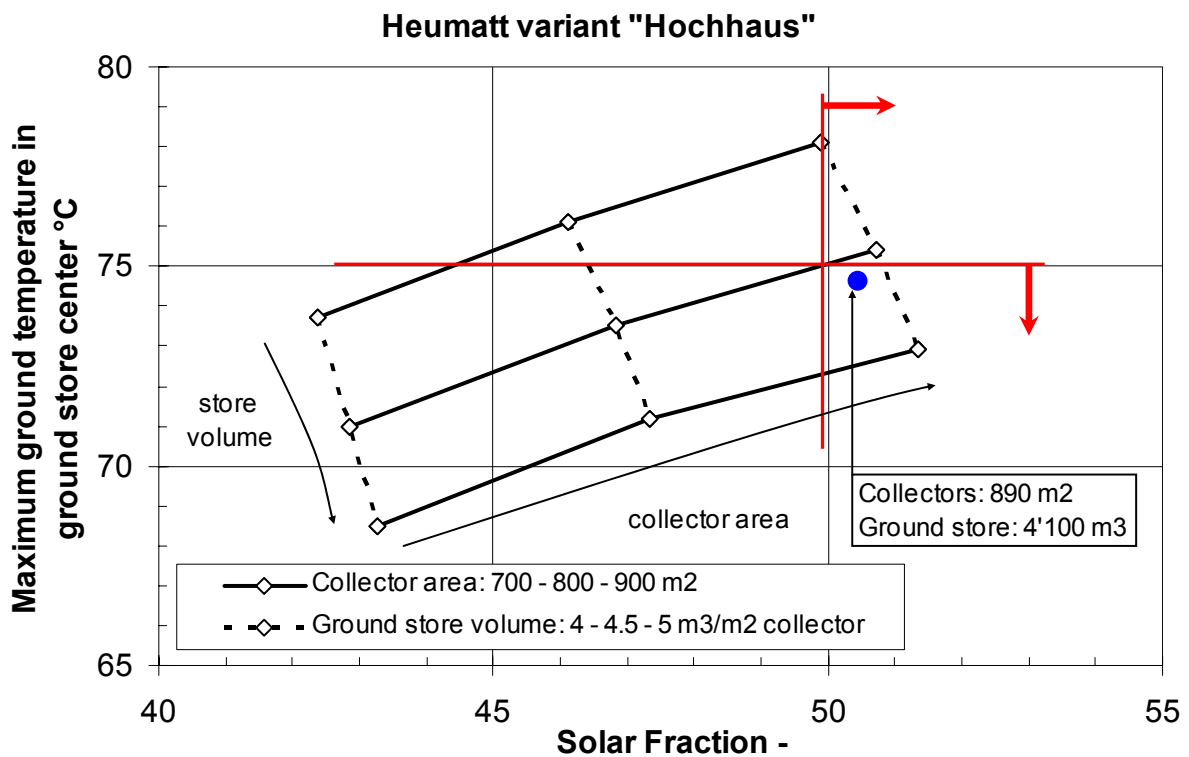

Figure 3.2: Maximum ground temperature in ground store center of the simulated systems in relation to the solar fraction for the "Hochhaus" variant.

An system that fulfils the requirements is shown with the circle on the two previous graphs. The system dimensions and performances are:

- Collector area 890 m² 2.2 m²/MWh annual load
- Buffer store volume 71 m³ 80 litre/m²
- Ground store volume 4'100 m³ 4.6 m³/m²
- Ground store vertical extension 8.4 m
- Total pipe length 17'000 m 18.8 m/m²

- Solar fraction 50.5 %
- Annual solar heat 205 MWh
- Solar cost 506 CHF/MWh

- Ground store cost 496 kCHF 45 %
- Buffer cost 51 kCHF 5 %
- Collector cost 543 kCHF 50 %
- Total cost 1'090 kCHF 100 %

- Ground store fraction (the 12th year of operation) 22 %
- Buffer store fraction (the 12th year of operation) 29 %

- Annual solar collector efficiency 33 %
- Annual ground store efficiency 54 %

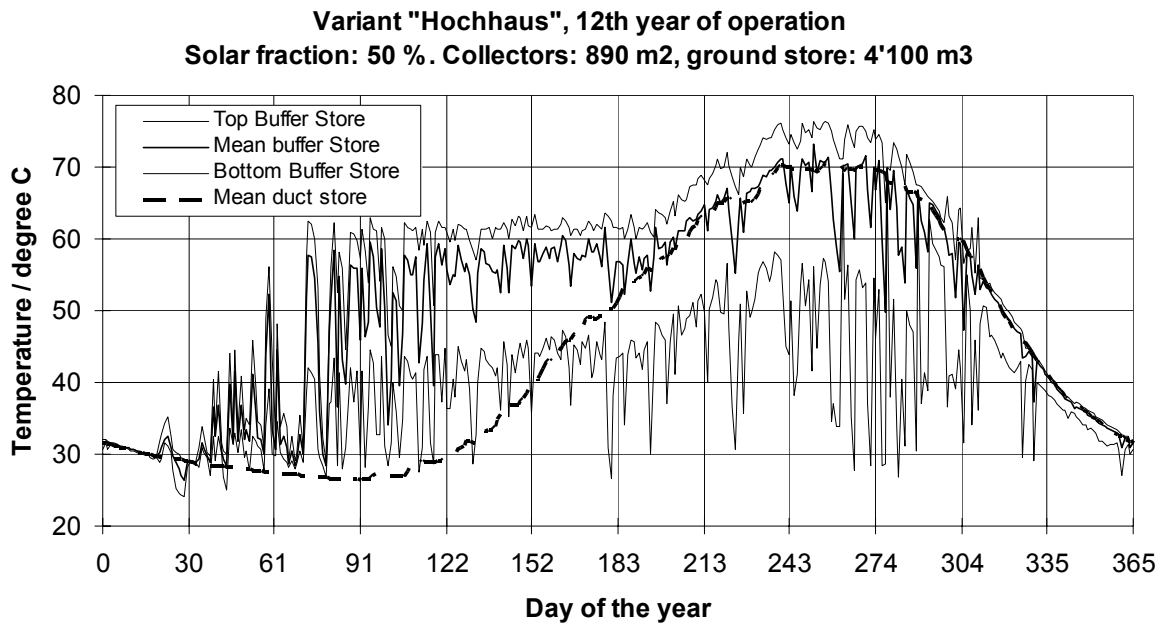

Figure 3.3: Evolution of the stores' temperatures for the "Hochhaus" variant.

SYSTEM PARAMETERS FOR THE “HOCHHAUS” VARIANT

Hochhaus, annual heat demand: 406 MWh/year, 64% space heating, 36% hot water, including 1% distribution losses

WEATHER DATA AND COLLECTOR ARRAY:			Parameter value
Location: Opfikon	latitude		47.3°
	altitude		450 m
	Swiss coordinate X		686 km
	Swiss coordinate Y		254 km
Horizon	constant		22°
Collector plane:	azimuth		30° West
	slope		22°
Monthly outside air temperature and global radiation in collector plane (with horizon), as calculated with Meteonorm (version 4.0)			
January	-0.1 °C	18 kWh/m ²	
February	0.3 °C	45 kWh/m ²	
March	4.7 °C	84 kWh/m ²	
April	8.0 °C	110 kWh/m ²	
May	12.6 °C	142 kWh/m ²	
June	15.5 °C	147 kWh/m ²	
July	18.8 °C	166 kWh/m ²	
August	18.1 °C	144 kWh/m ²	
September	14.4 °C	102 kWh/m ²	
October	9.7 °C	58 kWh/m ²	
November	4.0 °C	21 kWh/m ²	
December	1.4 °C	11 kWh/m ²	
Year	9.0 °C	1'048 kWh/m ²	
Collector type			Cobra Soltop (LTS 436)
Total area (referred to the absorber area): (m ²)			800 ?
Average transmittance-absorptance product: (-)			0.83
Overall loss coefficient (W/m ² K) collector ⁽¹⁾			3.69
(W/m ² K) pipe connections ⁽²⁾			0.24
Quadratic dependence of loss coefficient (W/m ² K ²)			0.009
Heat capacity (kJ/m ² K) collector			7
(kJ/m ² K) pipe connections ⁽³⁾			10
Incidence angle modifier (-) (bo in 1 - bo (1/cosθ - 1)) ⁽⁴⁾			0.1
Specific mass flow rate (kg/sec /m ² of collector area)			0.007
Heat carrier fluid in collectors:	density: kg/m ³		1'050
	specific heat: kJ/kgK		3.8

⁽¹⁾ local value of the collector loss coefficient. If we assume a constant loss coefficient, the overall loss coefficient is equal to $F'UL$ and the average transmittance-absorptance product to $F'(\tau\alpha)_n$

⁽²⁾ estimated for an average distance of 150 m from the collector fields to buffer store, average pipe loss factor of 0.4 W/mK and a collector field of 500 m².

⁽³⁾ estimated for an average distance of 150 m from the collector fields to buffer store, a fluid velocity of about 1 m/s in the steel connecting pipes and a collector field of 500 m².

⁽⁴⁾ bo is adjusted so that IAM = 0.94 for $\theta = 50^\circ$

Hochhaus, annual heat demand: 406 MWh/year, 64% space heating, 36% hot water, including 1% distribution losses

WEATHER DATA AND COLLECTOR ARRAY:	Parameter value
Pressure relief valve: max. allowed temperature in collector loop (°C)	100
Solar controller; temperature difference (outlet collectors - bottom buffer tank)	14
pump ON (K)	2
pump OFF (K)	
Solar heat exchanger (counter-flow heat exchanger): UA-value: (W/K /m ² of collector area)	100
Specific mass flow rate, cold side solar heat exchanger (kg/sec /m ² of collector area)	0.007
Heat carrier fluid, cold side solar heat exchanger:	
density kg/m ³ (water)	1'000
specific heat capacity: kJ/kgK (water)	4.19
Inlet pipe position in the buffer tank	variable for a stratified charge of the buffer

SHORT-TERM WATER BUFFER STORE:	Parameter value
Volume of water storage: (litre/m ² of collector area)	80 litre/m2
Vertical extension H (m) of the cylindrical storage (having a diameter D)	H = 4 x D
Number of nodes when simulated: (-)	11
Storage medium:	water
Initial store temperature: (°C)	10
Connecting pipes:	top and bottom
Storage insulation: thermal conductivity: (W/mK)	0.05
thickness: (m)	0.2
location:	uniformly placed on buffer envelope
Loading controller (ground store); temperature difference (buffer store top temperature - return fluid temperature from ground store)	
pump ON (K)	5
pump OFF (K)	1
If fluid temperature at the top of the buffer < 62 °C	pump OFF
Loading flow rate: variable	
minimum flow rate (kg/h):	100
maximum flow rate:	nominal flow rate in collectors
Flow adjusted within given limits so that: T _{ductIn} - T _{ductOut} > 3 K temperature stratification in buffer tank is not destroyed	

Hochhaus, annual heat demand: 406 MWh/year

SHORT-TERM WATER BUFFER STORE:	Parameter value
Unloading controller (ground store); temperature difference (return fluid temperature from ground store - buffer store top temperature) pump ON (K)	1
pump OFF (K)	0
Unloading flow rate: variable minimum flow rate (kg/h): maximum flow rate:	100 nominal flow rate in collec- tors
Flow adjusted within given limits so that: T _{ductOut} - T _{ductIn} > 3 K temperature stratification in buffer tank is not destroyed	

GROUND HEAT STORAGE	Parameter value
Volume: (m ³)	4'000 ?
Vertical extension: (m)	8.4
Pipe spacing (m) horizontal spacing x vertical spacing	0.35 x 0.7
Number of 160m long pipes	128
Distance between ground surface and top store: (m)	1
Insulation: location:	top and sides
thermal conductivity λ (W/mK)	0.075
thickness top 0.5 m with $\lambda = 0.075$ W/mK	
thickness side 0.4 m with $\lambda = 0.080$ W/mK	
equivalent thickness (top and side) with form effect (m) ⁽¹⁾	0.30
location:	bottom
thermal conductivity (W/mK)	0.08
thickness bottom 0.4 m with $\lambda = 0.080$ W/mK	
equivalent thickness (bottom) with form effect (m) ⁽¹⁾	0.80
Ground inside the store	
thermal conductivity: (W/mK) ⁽²⁾	1.87
volumetric heat capacity: (MJ/m ³ K)	2.4
Ground outside the store	
thermal conductivity: (W/mK)	2.9
volumetric heat capacity: (MJ/m ³ K)	2.2
Initial store and ground temperature: (°C)	10
Ground heat exchanger:	
heat carrier fluid:	water
pipe material	PEXC⁽⁴⁾
pipe outer diameter (mm)	20
thermal resistance from fluid to earth: (K/(W/m)) ⁽³⁾	0.15

⁽¹⁾ takes into account the form difference (and thus surface envelope) of the real storage with the simulated one (vertical cylinder). The form of the real storage is, for the first 2.4 m depth, a pyramid trunk with a slope of 45°. It lays on top of an inverted pyramid trunk (with a slope of 45°) for the remaining 6 m of the store vertical extension).

⁽²⁾ ground thermal conductivity of 2 W/mK in storage volume. The corrected value of 1.87 W/mK takes into account the rectangular arrangement of the pipes in the real store (0.35 x 0.7m).

⁽³⁾ conservative value only if Reynold number greater than 2300.

⁽⁴⁾ thermal conductivity of the pipe material (polyethylene XC): 0.35 W/mK.

Hochhaus, annual heat demand: 406 MWh/year, 64% space heating, 36% hot water, including 1% distribution losses

PIPES BETWEEN BUFFER STORE AND GROUND STORE	Parameter value
Connexion distance between buffer and ground store (m)	160
Internal diameter of one pipe (m) ⁽¹⁾	0.11
Loss factor of one pipe (W/K per linear m)	0.3
Ground temperature around pipes: sinusoidal temperature variation of period 1 year that is calculated for a depth of 1 meter from the ground surface .	2.4 °C Februar 15.6 °C August

⁽¹⁾ allows a flow rate of 29 m³/h that could be obtained with 1'200 m² of collector area and a fluid velocity inferior to 1 m/s in the connecting pipes.

LOAD SUBSYSTEMS	Parameter value
<u>Space heating distribution:</u>	
Variable flow rate component:	
maximum flow rate (kg/h):	6'000
(maximum flow rate in the space heating distribution network)	
Inlet fluid temperature, hot side: (boiler used if necessary). Temperature difference with the prescribed forward fluid temperature in distribution network (cold side of heat exchanger) (K)	+5
Load heat exchanger: (counter-flow)	
UA-value per annual MWh heat load (W/K /MWh)	130
<u>Hot water distribution:</u>	
Variable flow rate component:	
maximum flow rate (kg/h):	4'000
(maximum flow rate in the hot water distribution network)	
Inlet fluid temperature, hot side: (boiler used if necessary). Temperature difference with the prescribed forward fluid temperature in distribution network (cold side of heat exchanger) (K)	+5
Hot water heat exchanger: (counter-flow)	
UA-value per annual MWh hot water load (W/K /MWh)	70
Hot water tank (m ³ /(MWh/an))	0.007
Hot water pump: controlled by top and bottom water temperatures in hot water tank	recharge of water tank with a low flow during a long time

Hochhaus, annual heat demand: 406 MWh/year, 64% space heating, 36% hot water, including 1% distribution losses

Space heating heat demand

The forward and return fluid temperature in the distribution network are determined in relation to the outdoor air temperature. They are specified for two different outdoor air temperatures (T_{aCold} and T_{aFcte}). They are interpolated in-between with a straight line (see Pahud, 1996, p. 67). The temperature loss from the central station to the house sub-station is assumed to be 3 K when $-8\text{ }^{\circ}\text{C}$ outside and decreases linearly to 0 K when $20\text{ }^{\circ}\text{C}$ outside. The temperature loss is thus 0.9 K when it is $12\text{ }^{\circ}\text{C}$ outside.

1. T_{aCold} : outdoor air temperature below which the forward and return fluid temperatures in the distribution network are constant [$^{\circ}\text{C}$]
 T_{aCold} : **$-8\text{ }^{\circ}\text{C}$**
2. T_{fCold} : forward fluid temperature corresponding to T_{aCold} [$^{\circ}\text{C}$]
 T_{fCold} : **$53\text{ }^{\circ}\text{C}$** ($50\text{ }^{\circ}\text{C}$ in house sub-station)
3. T_{rCold} : return fluid temperature corresponding to T_{aCold} [$^{\circ}\text{C}$]
 T_{rCold} : **$34.5\text{ }^{\circ}\text{C}$**
4. T_{aFcte} : outdoor air temperature over which the forward fluid temperature is constant [$^{\circ}\text{C}$]
 T_{aFcte} : **$12\text{ }^{\circ}\text{C}$**
5. T_{fFcte} : forward fluid temperature corresponding to T_{aFcte} [$^{\circ}\text{C}$]
 T_{fFcte} : **$32.4\text{ }^{\circ}\text{C}$** ($31.5\text{ }^{\circ}\text{C}$ in house sub-station)
6. T_{rFcte} : return fluid temperature corresponding to T_{aFcte} [$^{\circ}\text{C}$]
 T_{rFcte} : **$26\text{ }^{\circ}\text{C}$**
7. T_{aRhot} : outdoor air temperature over which the return fluid temperature is constant [$^{\circ}\text{C}$]
 T_{aRhot} : -
8. T_{rRhot} : return fluid temperature corresponding to T_{rRhot} [$^{\circ}\text{C}$]
 T_{rRhot} : -

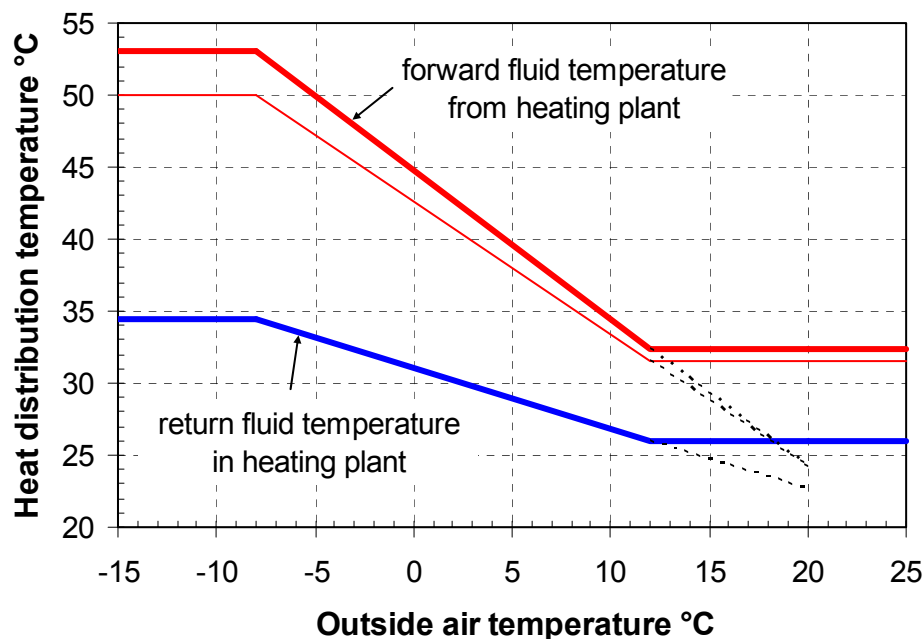

Figure 3.4: Forward and return fluid temperatures in the space heating distribution.

Total annual energy demand for heating:

258 MWh (261 MWh with 1% heat distribution losses)

Monthly heat demand:	Monthly outside temp.	Global horizontal (horizon)
January: 60 MWh	-0.1 °C	19 kWh/m ²
February: 43 MWh	0.3 °C	34 kWh/m ²
March: 34 MWh	4.7 °C	72 kWh/m ²
April: 11 MWh	8.0 °C	103 kWh/m ²
May: 1 MWh	12.6 °C	135 kWh/m ²
June: 0 MWh	15.5 °C	143 kWh/m ²
July: 0 MWh	18.8 °C	158 kWh/m ²
August: 0 MWh	18.1 °C	132 kWh/m ²
September: 0 MWh	14.4 °C	89 kWh/m ²
October: 12 MWh	9.7 °C	48 kWh/m ²
November: 37 MWh	4.0 °C	20 kWh/m ²
December: 60 MWh	1.4 °C	14 kWh/m ²
Year:	9.0 °C	964 kWh/m ²

Hot water heat demand

Return cold water temperature: **20 °C**

Hot water temperature: **57 °C** (55 °C in house sub-station)

Total annual energy demand for hot water:

143 MWh (145 MWh with 1% heat distribution losses)

4. Variant “Hochhaus + Kurzhaus”

The CSHPSS is designed for the two buildings “Hochhaus” and “Kurzhaus”. The annual heating demand amounts to **652 MWh/year** (66% space heating and 34% domestic hot water). The buffer store volume has an optimal value if comprised between 60 to 100 litres per square meter of collector area (see chapter 6). A value of 80 litre/m² is fixed. Losses in the collector array pipe connections is taken into account with an additional value added to the collector loss factor. Losses in the distribution system are estimated to be 1% of the annual heat distributed and is included in the heat load. The pipe connection losses between the buffer water store and the seasonal ground store are simulated with two pipe components. All the system parameters are listed at the end of this chapter. An optimal system that fulfill the following conditions is simulated.

OPTIMUM DESIGN REQUIREMENTS

The optimum system dimensions have to meet the following requirements:

- Solar fraction of at least 50%
- Maximum inlet fluid temperature in buffer store < 95 °C
- Maximum ground temperature in the centre part of the ground store < 75°C

The pipe arrangement in the ground store is rectangular and fixed to 0.35 x 0.7m. With this setting, the second conditions is always met if the third one is met. The third condition is necessary for a long life time of the pipes in the ground store. It imposes a minimum ground store volume to be fulfilled. It is also an advantage for the collector array which will never overheat during normal operation.

COST DATA

SUBSYSTEM COST	Parameter value
Solar collectors	610 CHF/m ²
Buffer store	710 CHF/m ³
Ground store	120 CHF/m ³

Annuity factor for collector subsystem: **0.10** (life time of 25 years)

Annuity factor for the two storages: **0.09** (life time of 40 years)

PARAMETER VARIATION

The scaling factor for the parameter variation is the collector area.

- collector area (absorber area): 1'100 – 1'200 – 1'300 – 1'400 m²
- ground store: 4 – 4.5 – 5 m³/m²

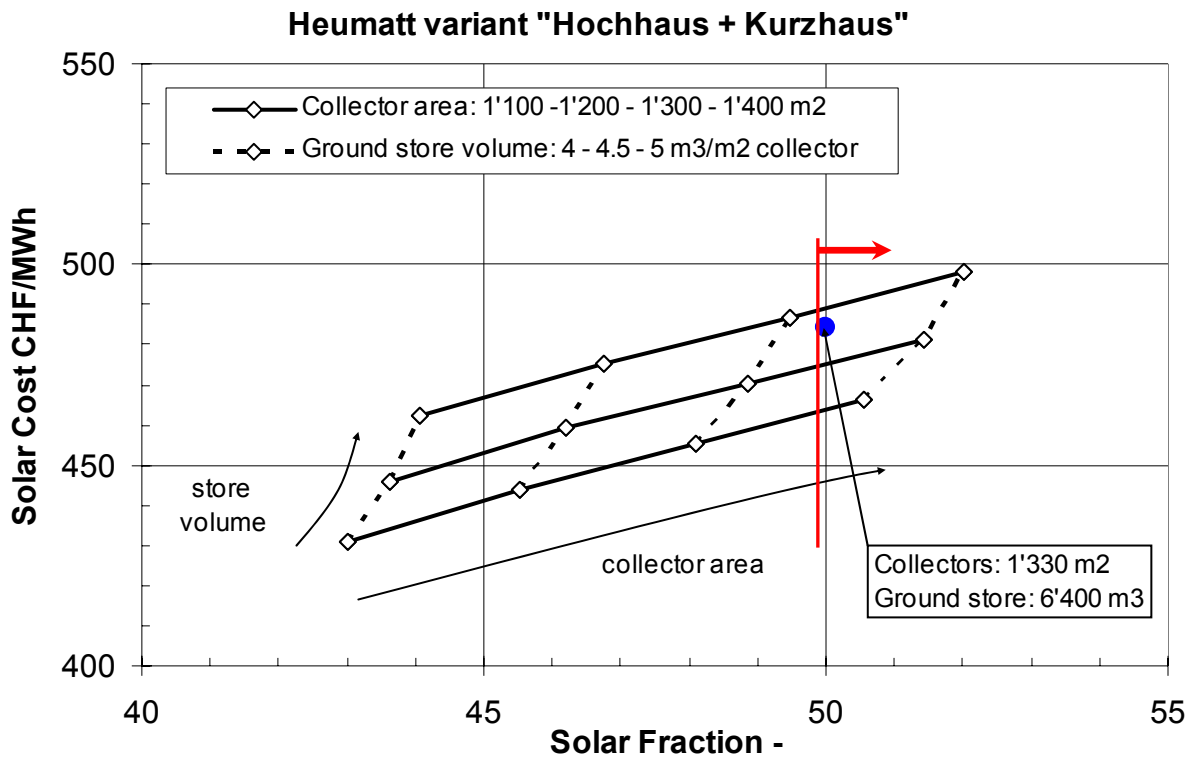

Figure 4.1: Solar cost of the simulated systems in relation to the solar fraction for the "Hochhaus + Kurzhaus" variant.

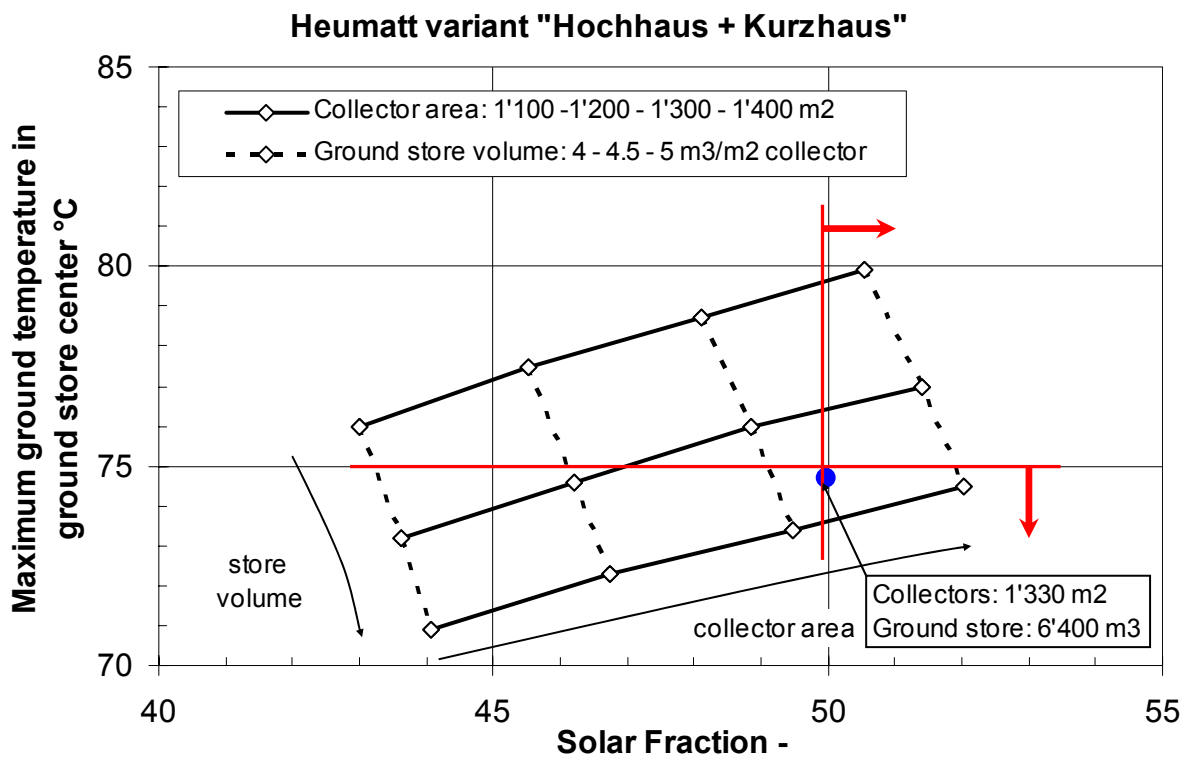

Figure 4.2: Maximum ground temperature in ground store center of the simulated systems in relation to the solar fraction for the "Hochhaus + Kurzhaus" variant.

An system that fulfils the requirements is shown with the circle on the two previous graphs. The system dimensions and performances are:

- Collector area 1'330 m² 2.0 m²/MWh annual load
- Buffer store volume 106 m³ 80 litre/m²
- Ground store volume 6400 m³ 4.8 m³/m²
- Ground store vertical extension 8.4 m
- Total pipe length 26'000 m 19.6 m/m²

- Solar fraction 50.0 %
- Annual solar heat 326 MWh
- Solar cost 484 CHF/MWh

- Ground store cost 775 kCHF 47 %
- Buffer cost 76 kCHF 4 %
- Collector cost 810 kCHF 49 %
- Total cost 1'660 kCHF 100 %

- Ground store fraction (the 12th year of operation) 22 %
- Buffer store fraction (the 12th year of operation) 28 %

- Annual solar collector efficiency 33 %
- Annual ground store efficiency 58 %

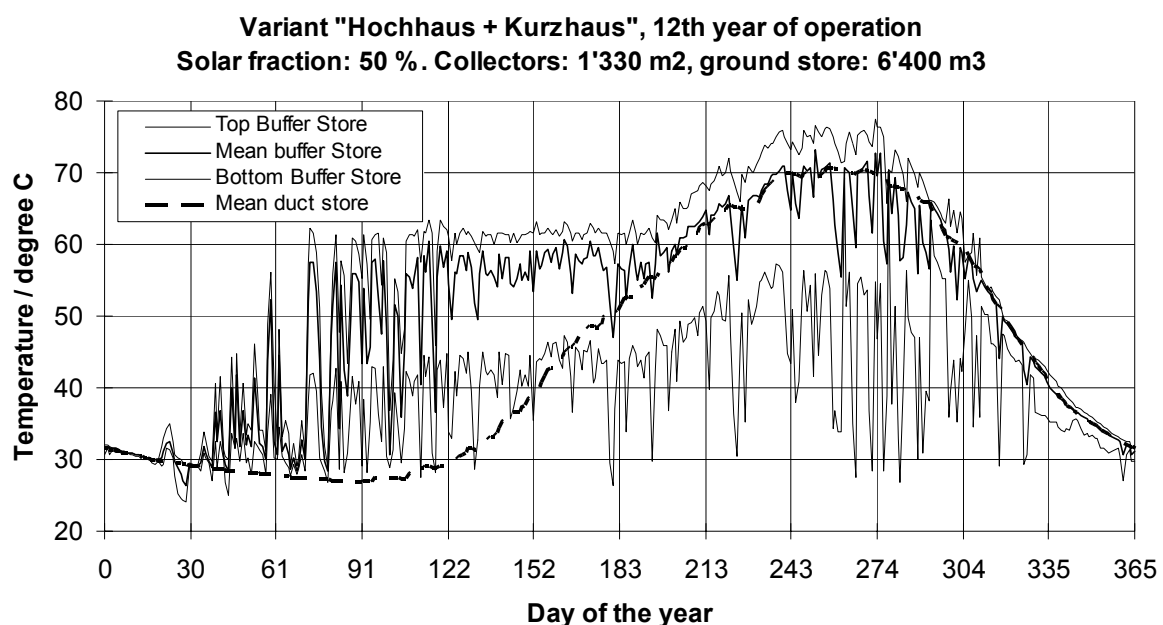

Figure 4.3: Evolution of the stores' temperatures for the "Hochhaus + Kurzhaus" variant.

SYSTEM PARAMETERS FOR THE “HOCHHAUS + KURZHAUS” VARIANT

Hochhaus + Kurzhaus, annual heat demand: 652 MWh/year, 66% space heating, 34% hot water, including 1% distribution losses

WEATHER DATA AND COLLECTOR ARRAY:			Parameter value
Location: Opfikon	latitude		47.3°
	altitude		450 m
	Swiss coordinate X		686 km
	Swiss coordinate Y		254 km
Horizon	constant		22°
Collector plane:	azimuth		30° West
	slope		22°
Monthly outside air temperature and global radiation in collector plane (with horizon), as calculated with Meteonorm (version 4.0)			
January	-0.1 °C	18 kWh/m ²	
February	0.3 °C	45 kWh/m ²	
March	4.7 °C	84 kWh/m ²	
April	8.0 °C	110 kWh/m ²	
May	12.6 °C	142 kWh/m ²	
June	15.5 °C	147 kWh/m ²	
July	18.8 °C	166 kWh/m ²	
August	18.1 °C	144 kWh/m ²	
September	14.4 °C	102 kWh/m ²	
October	9.7 °C	58 kWh/m ²	
November	4.0 °C	21 kWh/m ²	
December	1.4 °C	11 kWh/m ²	
Year	9.0 °C	1'048 kWh/m ²	
Collector type			Cobra Soltop (LTS 436)
Total area (referred to the absorber area): (m ²)			1'300 ?
Average transmittance-absorptance product: (-)			0.83
Overall loss coefficient (W/m ² K) collector ⁽¹⁾			3.69
(W/m ² K) pipe connections ⁽²⁾			0.24
Quadratic dependence of loss coefficient (W/m ² K ²)			0.009
Heat capacity (kJ/m ² K) collector			7
(kJ/m ² K) pipe connections ⁽³⁾			10
Incidence angle modifier (-) (bo in 1 - bo (1/cosθ - 1)) ⁽⁴⁾			0.1
Specific mass flow rate (kg/sec /m ² of collector area)			0.007
Heat carrier fluid in collectors:	density: kg/m ³		1'050
	specific heat: kJ/kgK		3.8

⁽¹⁾ local value of the collector loss coefficient. If we assume a constant loss coefficient, the overall loss coefficient is equal to $F'UL$ and the average transmittance-absorptance product to $F'(\tau\alpha)_n$

⁽²⁾ estimated for an average distance of 150 m from the collector fields to buffer store, average pipe loss factor of 0.4 W/mK and a collector field of 500 m².

⁽³⁾ estimated for an average distance of 150 m from the collector fields to buffer store, a fluid velocity of about 1 m/s in the steel connecting pipes and a collector field of 500 m².

⁽⁴⁾ bo is adjusted so that IAM = 0.94 for $\theta = 50^\circ$

Hochhaus + Kurzhaus, annual heat demand: 652 MWh/year, 66% space heating, 34% hot water, including 1% distribution losses

WEATHER DATA AND COLLECTOR ARRAY:	Parameter value
Pressure relief valve: max. allowed temperature in collector loop (°C)	100
Solar controller; temperature difference (outlet collectors - bottom buffer tank)	14
pump ON (K)	2
pump OFF (K)	
Solar heat exchanger (counter-flow heat exchanger):	
UA-value: (W/K /m ² of collector area)	100
Specific mass flow rate, cold side solar heat exchanger (kg/sec /m ² of collector area)	0.007
Heat carrier fluid, cold side solar heat exchanger:	
density kg/m ³ (water)	1'000
specific heat capacity: kJ/kgK (water)	4.19
Inlet pipe position in the buffer tank	variable for a stratified charge of the buffer

SHORT-TERM WATER BUFFER STORE:	Parameter value
Volume of water storage: (litre/m ² of collector area)	80 litre/m2
Vertical extension H (m) of the cylindrical storage (having a diameter D)	H = 4 x D
Number of nodes when simulated: (-)	11
Storage medium:	water
Initial store temperature: (°C)	10
Connecting pipes:	top and bottom
Storage insulation: thermal conductivity: (W/mK)	0.05
thickness: (m)	0.2
location:	uniformly placed on buffer envelope
Loading controller (ground store); temperature difference (buffer store top temperature - return fluid temperature from ground store)	
pump ON (K)	5
pump OFF (K)	1
If fluid temperature at the top of the buffer < 62 °C	pump OFF
Loading flow rate: variable	
minimum flow rate (kg/h):	100
maximum flow rate:	nominal flow rate in collectors
Flow adjusted within given limits so that:	
T _{ductIn} - T _{ductOut} > 3 K	
temperature stratification in buffer tank is not destroyed	

Hochhaus + Kurzhaus, annual heat demand: 652 MWh/year

SHORT-TERM WATER BUFFER STORE:	Parameter value
Unloading controller (ground store); temperature difference (return fluid temperature from ground store - buffer store top temperature) pump ON (K)	1
pump OFF (K)	0
Unloading flow rate: variable minimum flow rate (kg/h): maximum flow rate:	100 nominal flow rate in collec- tors
Flow adjusted within given limits so that: T _{ductOut} - T _{ductIn} > 3 K temperature stratification in buffer tank is not destroyed	

GROUND HEAT STORAGE	Parameter value
Volume: (m ³)	6'000 ?
Vertical extension: (m)	8.4
Pipe spacing (m) horizontal spacing x vertical spacing	0.35 x 0.7
Number of 160m long pipes	128
Distance between ground surface and top store: (m)	1
Insulation: location:	top and sides
thermal conductivity λ (W/mK)	0.075
thickness top 0.5 m with $\lambda = 0.075$ W/mK	
thickness side 0.4 m with $\lambda = 0.080$ W/mK	
equivalent thickness (top and side) with form effect (m) ⁽¹⁾	0.30
location:	bottom
thermal conductivity (W/mK)	0.08
thickness bottom 0.4 m with $\lambda = 0.080$ W/mK	
equivalent thickness (bottom) with form effect (m) ⁽¹⁾	0.80
Ground inside the store	
thermal conductivity: (W/mK) ⁽²⁾	1.87
volumetric heat capacity: (MJ/m ³ K)	2.4
Ground outside the store	
thermal conductivity: (W/mK)	2.9
volumetric heat capacity: (MJ/m ³ K)	2.2
Initial store and ground temperature: (°C)	10
Ground heat exchanger:	
heat carrier fluid:	water
pipe material	PEXC⁽⁴⁾
pipe outer diameter (mm)	20
thermal resistance from fluid to earth: (K/(W/m)) ⁽³⁾	0.15

⁽¹⁾ takes into account the form difference (and thus surface envelope) of the real storage with the simulated one (vertical cylinder). The form of the real storage is, for the first 2.4 m depth, a pyramid trunk with a slope of 45°. It lays on top of an inverted pyramid trunk (with a slope of 45°) for the remaining 6 m of the store vertical extension).

⁽²⁾ ground thermal conductivity of 2 W/mK in storage volume. The corrected value of 1.87 W/mK takes into account the rectangular arrangement of the pipes in the real store (0.35 x 0.7m).

⁽³⁾ conservative value only if Reynold number greater than 2300.

⁽⁴⁾ thermal conductivity of the pipe material (polyethylene XC): 0.35 W/mK.

Hochhaus + Kurzhaus, annual heat demand: 652 MWh/year, 66% space heating, 34% hot water, including 1% distribution losses

PIPES BETWEEN BUFFER STORE AND GROUND STORE	Parameter value
Connexion distance between buffer and ground store (m)	160
Internal diameter of one pipe (m) ⁽¹⁾	0.11
Loss factor of one pipe (W/K per linear m)	0.3
Ground temperature around pipes: sinusoidal temperature variation of period 1 year that is calculated for a depth of 1 meter from the ground surface .	2.4 °C Februar 15.6 °C August

⁽¹⁾ allows a flow rate of 29 m³/h that could be obtained with 1'200 m² of collector area and a fluid velocity inferior to 1 m/s in the connecting pipes.

LOAD SUBSYSTEMS	Parameter value
<u>Space heating distribution:</u>	
Variable flow rate component:	
maximum flow rate (kg/h):	10'000
(maximum flow rate in the space heating distribution network)	
Inlet fluid temperature, hot side: (boiler used if necessary). Temperature difference with the prescribed forward fluid temperature in distribution network (cold side of heat exchanger) (K)	+5
Load heat exchanger: (counter-flow)	
UA-value per annual MWh heat load (W/K /MWh)	130
<u>Hot water distribution:</u>	
Variable flow rate component:	
maximum flow rate (kg/h):	6'000
(maximum flow rate in the hot water distribution network)	
Inlet fluid temperature, hot side: (boiler used if necessary). Temperature difference with the prescribed forward fluid temperature in distribution network (cold side of heat exchanger) (K)	+5
Hot water heat exchanger: (counter-flow)	
UA-value per annual MWh hot water load (W/K /MWh)	70
Hot water tank (m ³ /(MWh/an))	0.007
Hot water pump: controlled by top and bottom water temperatures in hot water tank	recharge of water tank with a low flow during a long time

Hochhaus + Kurzhaus, annual heat demand: 652 MWh/year, 66% space heating, 34% hot water, including 1% distribution losses

Space heating heat demand

The forward and return fluid temperature in the distribution network are determined in relation to the outdoor air temperature. They are specified for two different outdoor air temperatures (T_{aCold} and T_{aFcte}). They are interpolated in-between with a straight line (see Pahud, 1996, p. 67). The temperature loss from the central station to the house sub-station is assumed to be 3 K when $-8\text{ }^{\circ}\text{C}$ outside and decreases linearly to 0 K when $20\text{ }^{\circ}\text{C}$ outside. The temperature loss is thus 0.9 K when it is $12\text{ }^{\circ}\text{C}$ outside.

1. T_{aCold} : outdoor air temperature below which the forward and return fluid temperatures in the distribution network are constant [$^{\circ}\text{C}$]
 T_{aCold} : **$-8\text{ }^{\circ}\text{C}$**
2. T_{fCold} : forward fluid temperature corresponding to T_{aCold} [$^{\circ}\text{C}$]
 T_{fCold} : **$53\text{ }^{\circ}\text{C}$** ($50\text{ }^{\circ}\text{C}$ in house sub-station)
3. T_{rCold} : return fluid temperature corresponding to T_{aCold} [$^{\circ}\text{C}$]
 T_{rCold} : **$34.5\text{ }^{\circ}\text{C}$**
4. T_{aFcte} : outdoor air temperature over which the forward fluid temperature is constant [$^{\circ}\text{C}$]
 T_{aFcte} : **$12\text{ }^{\circ}\text{C}$**
5. T_{fFcte} : forward fluid temperature corresponding to T_{aFcte} [$^{\circ}\text{C}$]
 T_{fFcte} : **$32.4\text{ }^{\circ}\text{C}$** ($31.5\text{ }^{\circ}\text{C}$ in house sub-station)
6. T_{rFcte} : return fluid temperature corresponding to T_{aFcte} [$^{\circ}\text{C}$]
 T_{rFcte} : **$26\text{ }^{\circ}\text{C}$**
7. T_{aRhot} : outdoor air temperature over which the return fluid temperature is constant [$^{\circ}\text{C}$]
 T_{aRhot} : -
8. T_{rRhot} : return fluid temperature corresponding to T_{aRhot} [$^{\circ}\text{C}$]
 T_{rRhot} : -

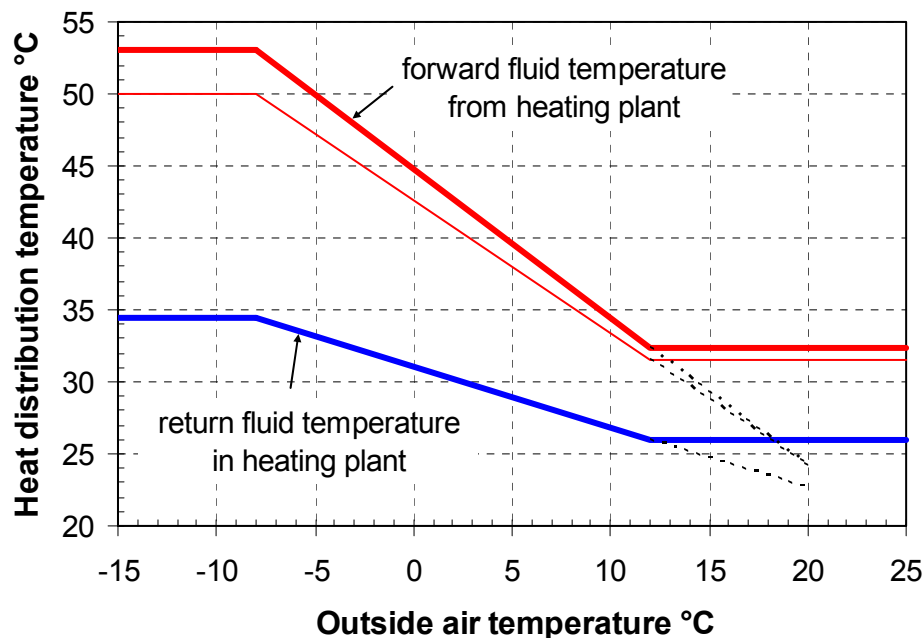

Figure 4.4: Forward and return fluid temperatures in the space heating distribution.

Total annual energy demand for heating:

	427 MWh	(432 MWh with 1% heat distribution losses)	
Monthly heat demand:		Monthly outside temp.	Global horizontal (horizon)
January:	96 MWh	-0.1 °C	19 kWh/m ²
February:	71 MWh	0.3 °C	34 kWh/m ²
March:	57 MWh	4.7 °C	72 kWh/m ²
April:	21 MWh	8.0 °C	103 kWh/m ²
May:	3 MWh	12.6 °C	135 kWh/m ²
June:	0 MWh	15.5 °C	143 kWh/m ²
July:	0 MWh	18.8 °C	158 kWh/m ²
August:	0 MWh	18.1 °C	132 kWh/m ²
September:	0 MWh	14.4 °C	89 kWh/m ²
October:	22 MWh	9.7 °C	48 kWh/m ²
November:	61 MWh	4.0 °C	20 kWh/m ²
December:	96 MWh	1.4 °C	14 kWh/m ²
Year:		9.0 °C	964 kWh/m ²

Hot water heat demand

Return cold water temperature: **20 °C**
 Hot water temperature: **57 °C** (55 °C in house sub-station)

Total annual energy demand for hot water:

219 MWh **(221 MWh with 1% heat distribution losses)**

5. Rules of thumb for sizing the Heumatt CSH PSS

The system parameters of the two optimal systems found in chapter 3 and 4 can be expressed in terms of annual heating energy unit and collector area unit. They are:

Variant	Hochhaus	Hochhaus + Kurzhaus
Annual heat load	406 MWh	652 MWh
Solar fraction	50 %	50 %
Collector area ⁽¹⁾ per MWh annual load	2.2 m ² /MWh	2.0 m ² /MWh
Buffer store volume per m ² collector area	80 litre/m ²	80 litre/m ²
Ground store volume per m ² collector area	4.6 m ³ /m ²	4.8 m ³ /m ²
Total pipe length per m ² collector area	18.8 m/m ²	19.6 m/m ²
Annual solar collector efficiency	33 %	33 %
Annual ground store efficiency	54 %	58 %

⁽¹⁾ absorber area

For another system similar to Heumatt (same heat load with similar temperature levels in the heat distribution, same weather conditions, same solar fraction), these parameters can be used for a quick estimation of the system size. Note that the system thermal performances are improving with a larger system, and consequently change the rules of thumb. The variant “Hochhaus + Kurzhaus + Langhaus”, initially simulated to determine optimal system parameters (see chapter 6), can not be directly compared to these two variants due to some differences in the system simulation. For example, the heat losses between the buffer store and the ground store were not simulated.

6. Optimal system design and sensitivity to some parameters

The CSHPSS is designed for the three buildings “Hochhaus”, “Kurzhaus” and “Langhaus”. The annual heating demand amounts to **986 MWh/year** (67% space heating and 33% domestic hot water, including 3% distribution heat losses). Slightly different parameters respectively to the variant “Hochhaus” and “Hochhaus + Kurzhaus” are set for the ground store insulation and collector pipe losses. The greatest difference comes probably from the pipes losses between the buffer store and the ground store that are not simulated in this case. These differences may slightly influence the thermal performances of the system but not the optimal system design parameters.

The simulation where performed with the following subsystem costs. The ground store cost depend on the total pipe length of the ground heat exchanger.

SUBSYSTEM COST	Parameter value
Solar collectors	610 CHF/m²
Buffer store	710 CHF/m³
Ground store (correspond to 120 CHF/m ³ with a store volume of 8'000 m ³ and a total pipe length of 28'600 m)	112.5 CHF/m³ + 2.1 CHF/m
Annuity factor for collector subsystem:	0.10 (life time of 25 years)
Annuity factor for the two storages:	0.09 (life time of 40 years)

Parameter variation simulated

The scaling factor for the parameter variation is the collector area:

collector area (absorber area):	1'600 – 1'700 – 1'800 m ²
buffer store:	60 – 80 – 100 – 120 litre/m ²
ground store:	4 – 5 – 6 m ³ /m ²
pipe length in ground store:	12 – 16 – 20 m/m ²

Optimal parameter value

An optimal parameter value is determined in a “solar cost” – “solar fraction” diagram. An optimal value is found for a given solar fraction. A parameter has an optimal value when the parameter variation curve presents a minimum relatively to the “expansion path”, which is the curve “solar cost – solar fraction” for the optimal systems (the best curve (or lowest curve) that could be obtained in the diagram). The slope of the collector area curve is a good indication of the slope of the expansion path and can be used for it. The optimal parameter value is optimal when the distance to the lowest collector area curve is minimum.

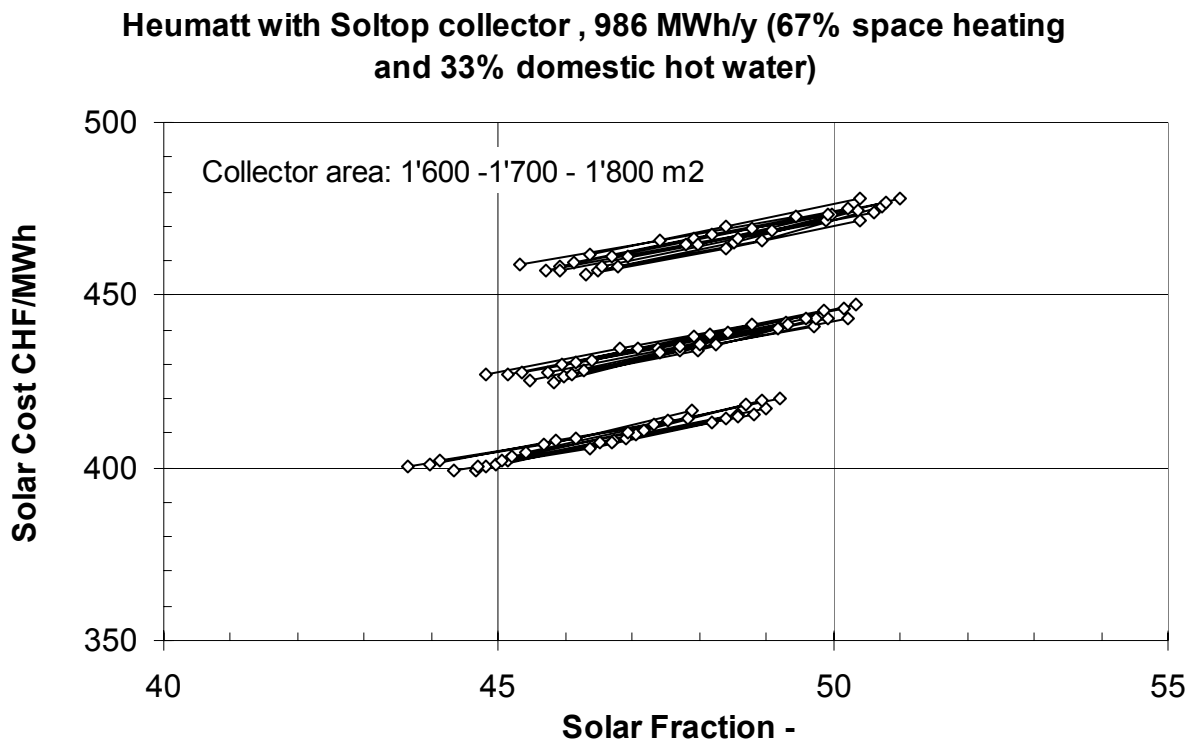

Figure 6.1: Collector area curves in the diagram “solar cost” – “solar fraction” for the variant “Hochhaus + Kurzhaus + Langhaus”.

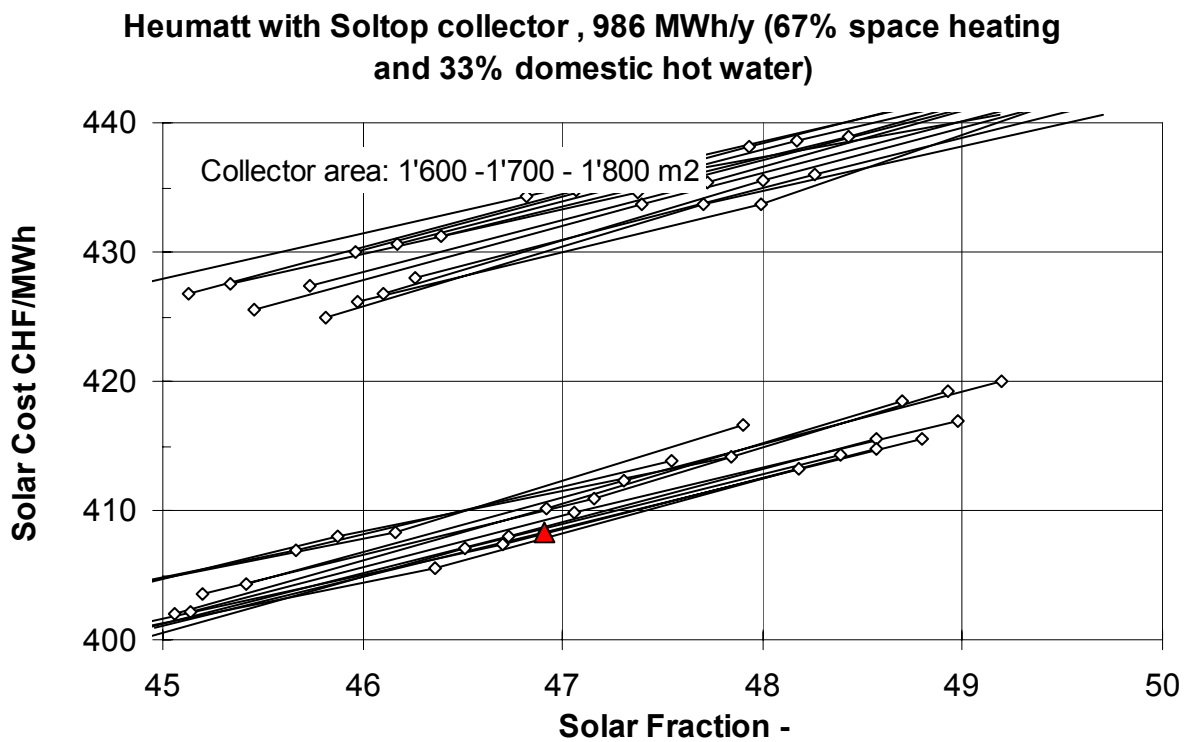

Figure 6.2: Zoom in the collector area curves.

Heumatt with Soltop collector , 986 MWh/y (67% space heating and 33% domestic hot water)

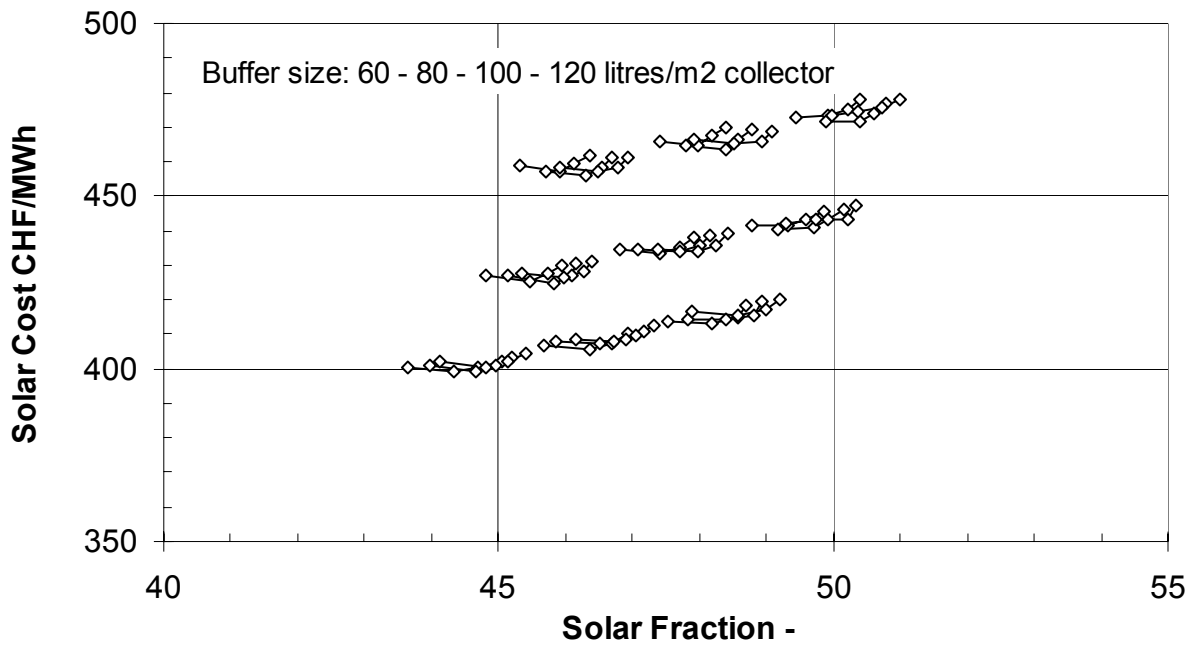

Figure 6.3: Buffer store volume curves in the diagram “solar cost” – “solar fraction” for the variant “Hochhaus + Kurzhaus + Langhaus”.

Heumatt with Soltop collector , 986 MWh/y (67% space heating and 33% domestic hot water)

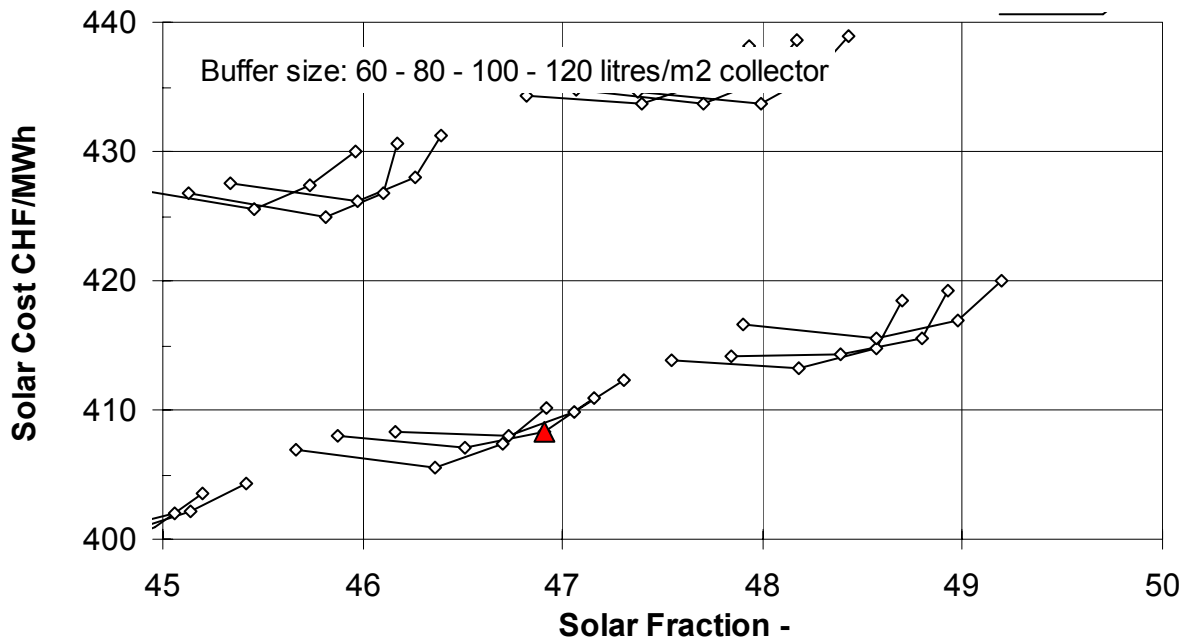

Figure 6.4: Zoom in the buffer store volume curves.

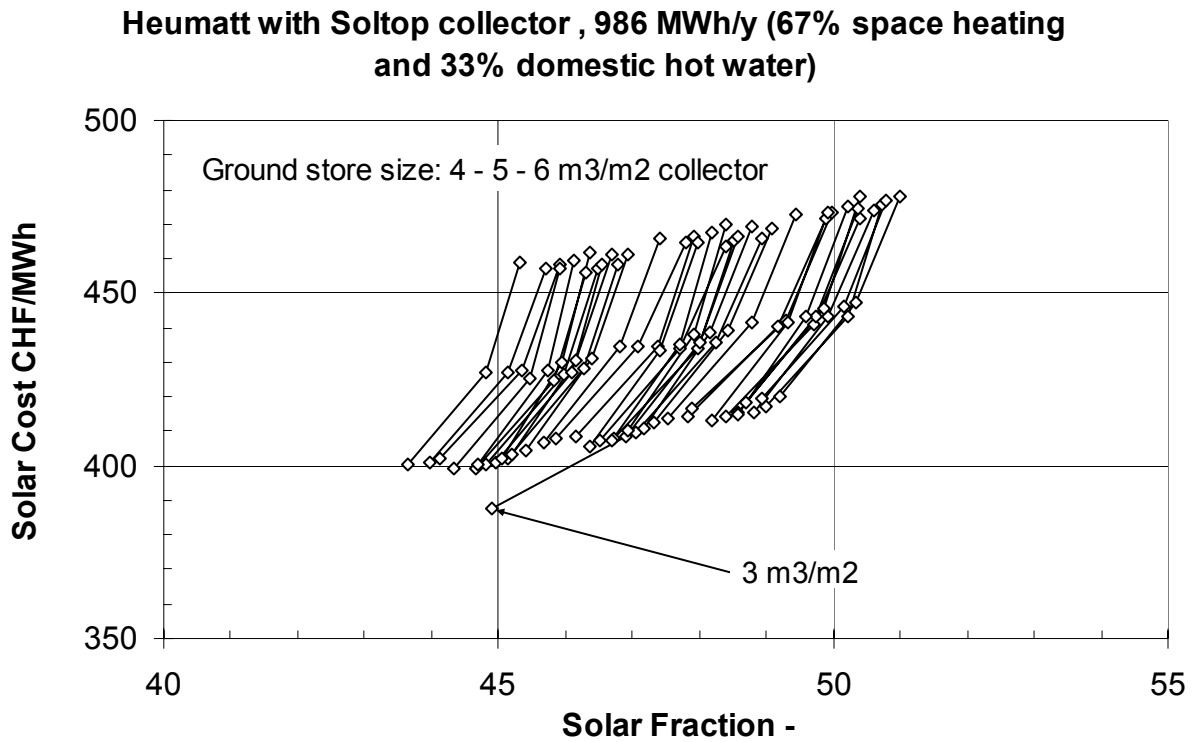

Figure 6.5: Ground store volume curves in the diagram “solar cost” – “solar fraction” for the variant “Hochhaus + Kurzhaus + Langhaus”.

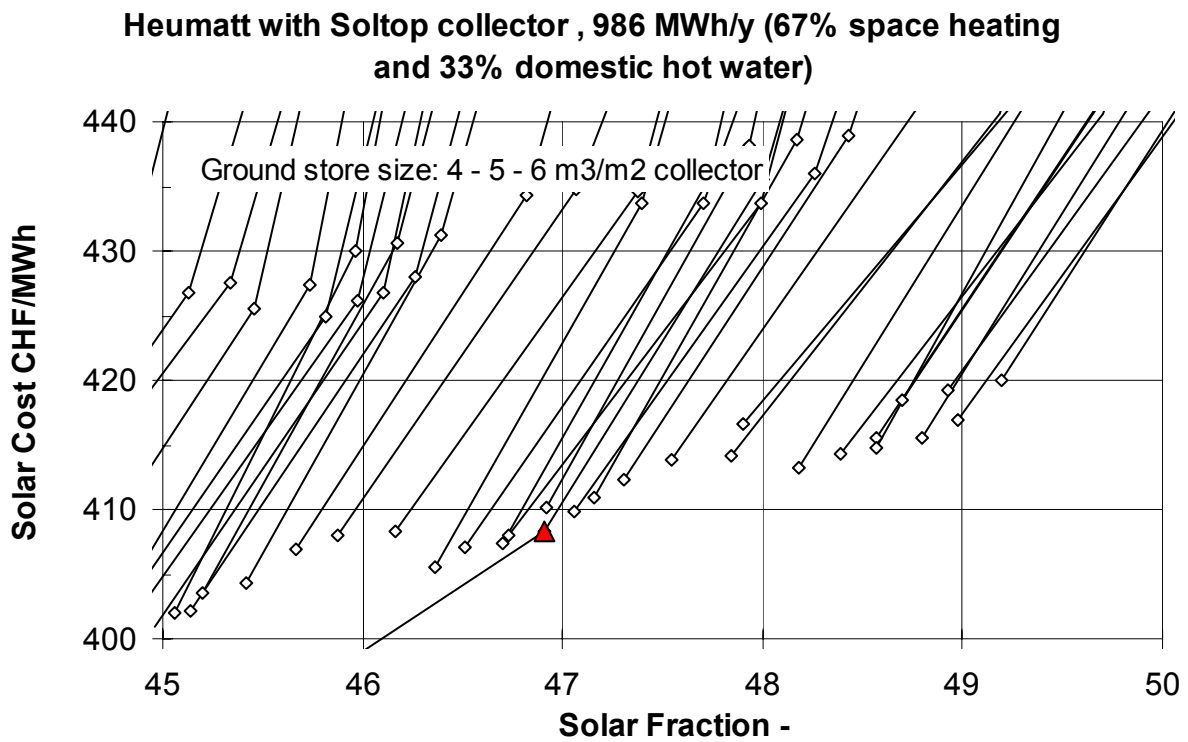

Figure 6.6: Zoom in the ground store volume curves.

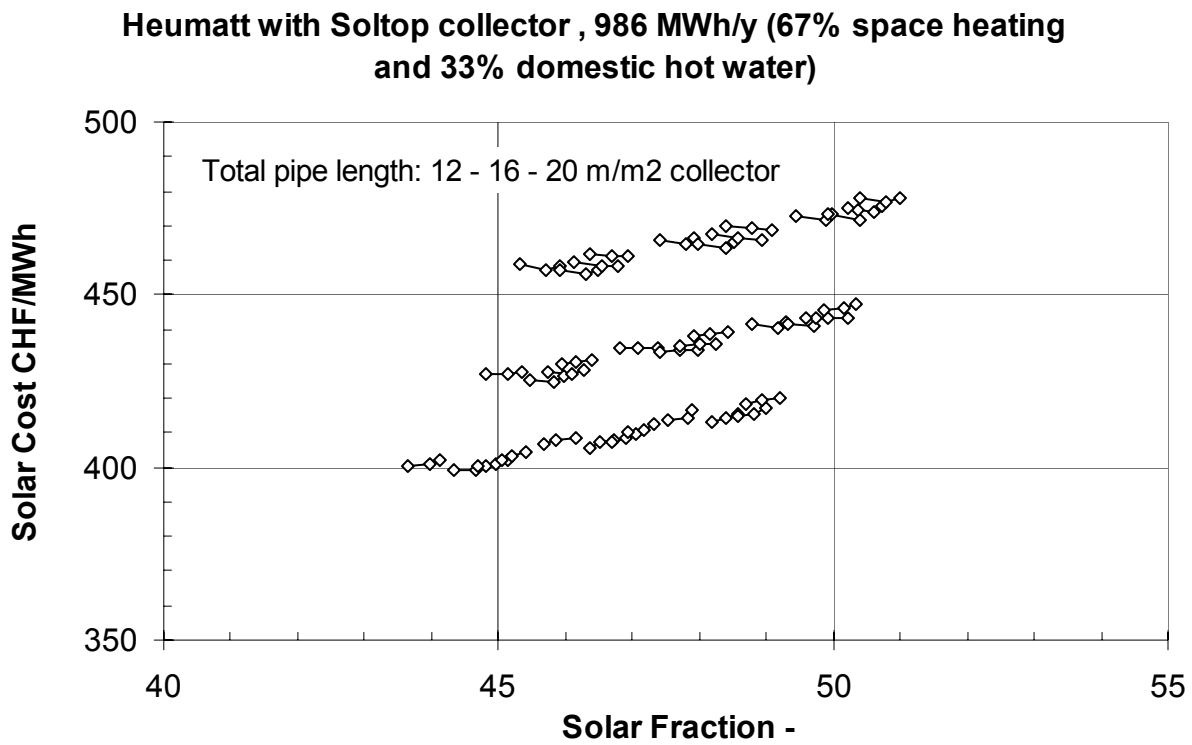

Figure 6.7: Ground store pipe length curves in the diagram “solar cost” – “solar fraction” for the variant “Hochhaus + Kurzhaus + Langhaus”.

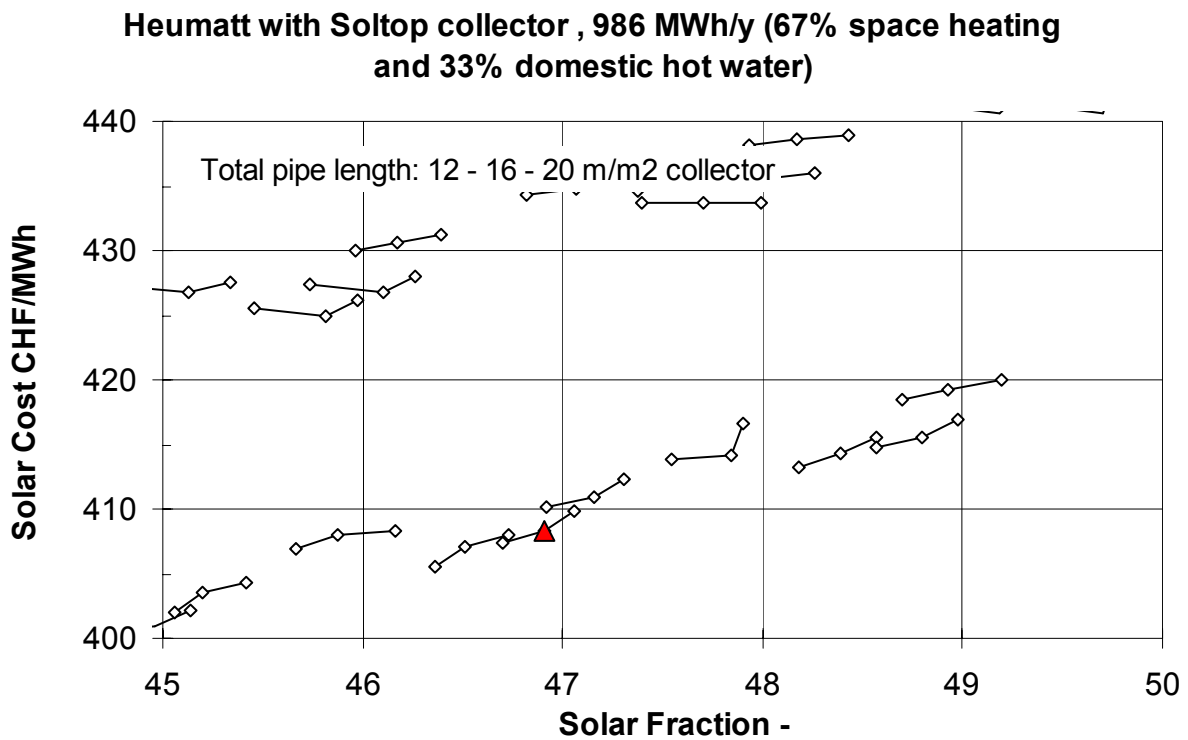

Figure 6.8: Zoom in the ground store pipe length curves.

Collector area

- The solar cost increases with the collector area. The maximal area at disposition for the collectors limits the solar fraction.

Buffer store volume

- An optimal buffer store volume is found for 80 – 100 litres per m² of collector area.

Ground store volume

- The ground store volume does not present an optimal value in the varied range. In figure 6.5, a smaller ground store volume would still lower the solar cost. However, the decrease of the solar fraction has to be compensated by a larger collector area. The optimum system design would lead to a large collector area relatively to the ground store volume. The consequence is a high temperature in the collectors and the store, which may be a cause of technical problems (too high temperature for the pipes in the ground store, or even evaporation of the heat carrier fluid in the collector absorbers).

Ground store pipe length

- Sensitivity to the pipe length is weak in the varied range. The optimal value lies between 16 – 20 m/m² of collector area.

A simulation of this system without ground store reduces the solar fraction to 31%. Overheating problems in the collector field during summer are important.

The **system shown with the triangle** in figure 6.2, 6.4, 6.6 and 6.8 has the following characteristics:

- | | | |
|--|----------------------|-------------------------------------|
| • Collector area | 1'700 m ² | 1.7 m ² /MWh annual load |
| • Buffer store volume | 170 m ³ | 100 litre/m ² |
| • Ground store volume | 6800 m ³ | 4.0 m ³ /m ² |
| • Ground store vertical extension | 8.4 m | |
| • Total pipe length | 27'200 m | 16 m/m ² |
| | | |
| • Solar fraction | 46.9 % | |
| • Annual solar heat | 460 MWh | |
| • Solar cost | 408 CHF/MWh | |
| | | |
| • Maximum temperature in collectors | 98.9 °C | |
| | | |
| • Ground store cost | 822 kCHF | 42 % |
| • Buffer cost | 121 kCHF | 6 % |
| • Collector cost | 1'037 kCHF | 52 % |
| • Total cost | 1'980 kCHF | 100 % |
| | | |
| • Ground store fraction (the 12 th year of operation) | | 19 % |
| • Buffer store fraction (the 12 th year of operation) | | 28 % |
| | | |
| • Annual solar collector efficiency | | 32 % |
| • Annual ground store efficiency | | 67 % |

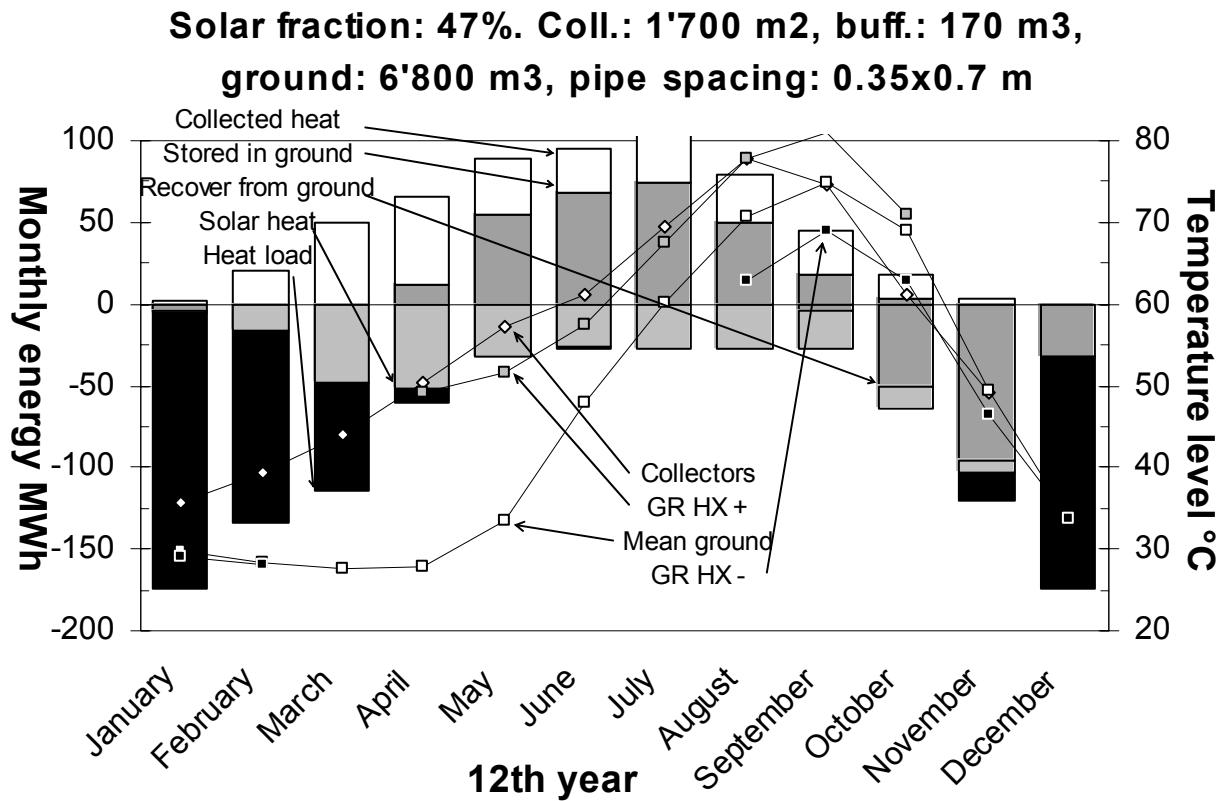

Figure 6.9: Monthly heat balance of the system and temperature levels (variant “Hochhaus + Kurzhaus + Langhaus”). GR HX: fluid temperature in the GRound Heat eXchanger when loading (+) or unloading (-) the ground store.

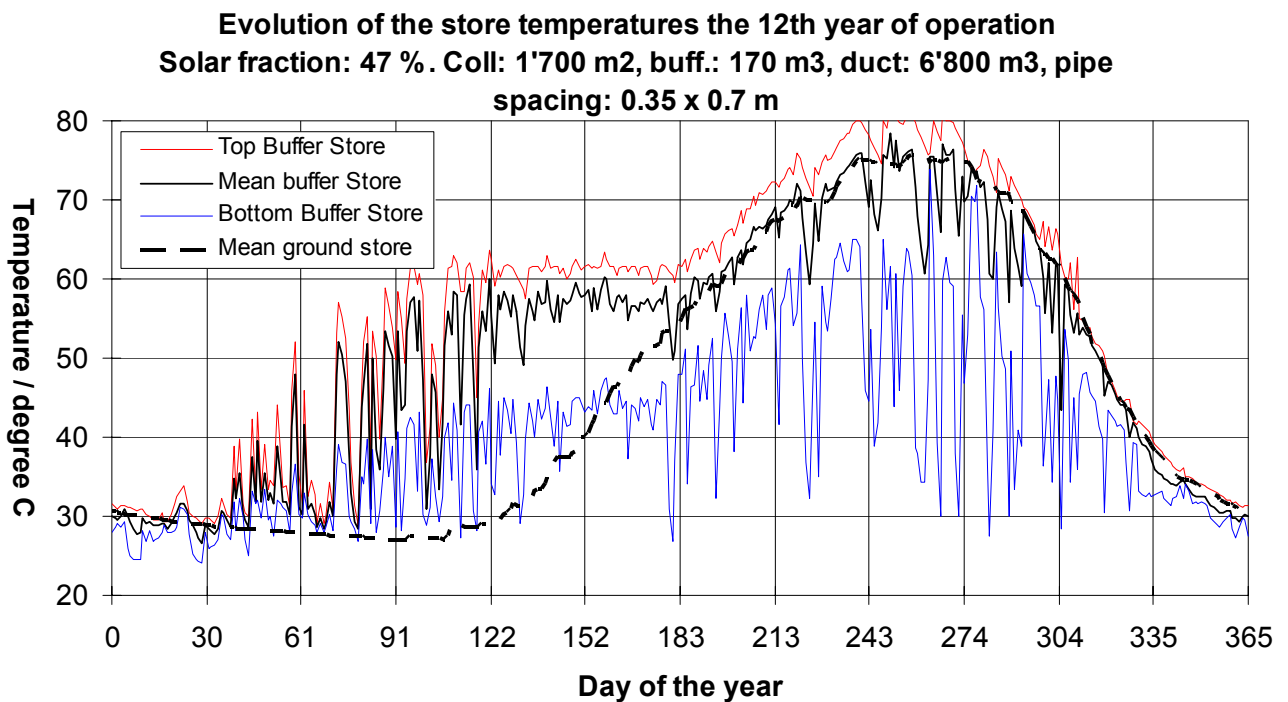

Figure 6.10: Store temperature evolution the 12th year of operation (variant “Hochhaus + Kurzhaus + Langhaus”).

SENSITIVITY TO GROUND STORE COST

The cost of the ground storage is **halved**. It is set to 60 CHF/m³ instead of 120 CHF/m³.

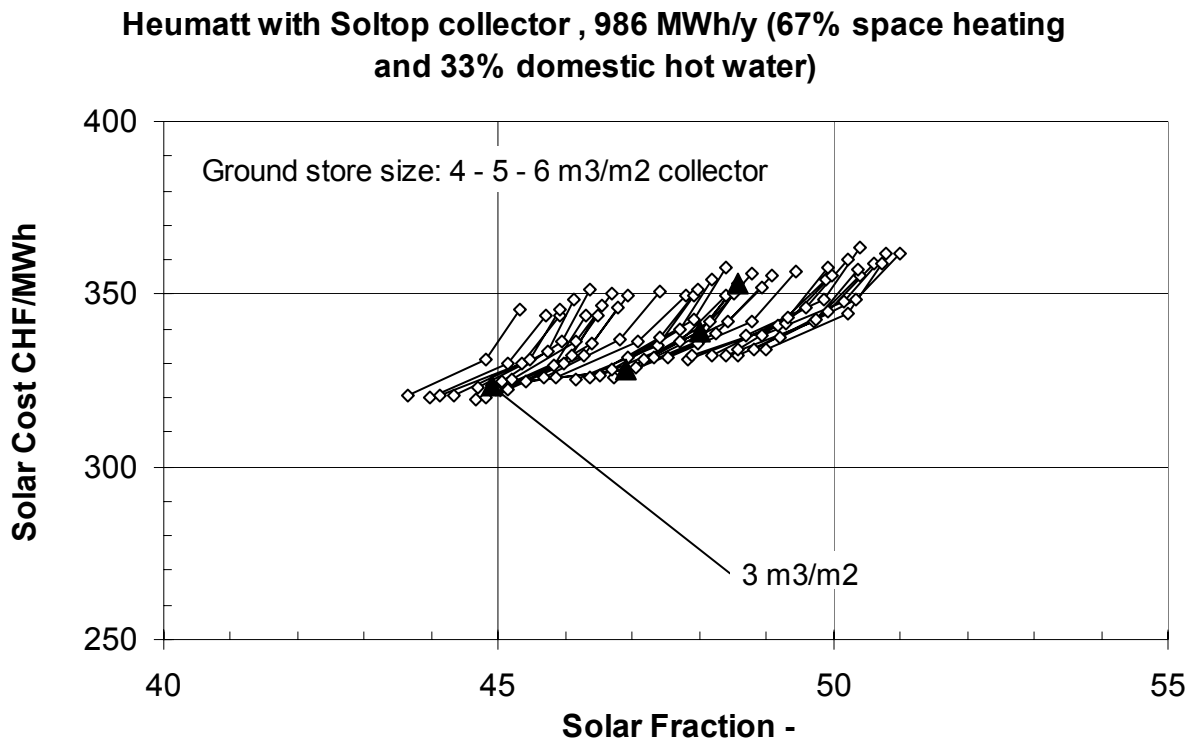

Figure 6.11: Ground store volume curves in the diagram “solar cost” – “solar fraction” for a “twice-cheaper” ground store.

In this case, the curves are not as steep as before. An optimal value of 4 m³/m² of collector is found. The optimal pipe length is also longer.

SENSITIVITY TO SUBSYSTEM COSTS

A **low** cost variant and a **high** cost variant are defined to investigate the sensitivity of the optimal system design to the relative cost of the subsystems.

The low cost variant is defined by costs used so far:

SUBSYSTEM COST – LOW COST VARIANT	Parameter value
Solar collectors	610 CHF/m ²
Buffer store	710 CHF/m ³
Ground store (correspond to 120 CHF/m ³ with a store volume of 8'000 m ³ and a total pipe length of 28'600 m)	112.5 CHF/m ³ + 2.1 CHF/m

The high cost variant is defined by higher subsystem costs. The specific buffer store cost is much higher than the other subsystem costs (more than 4 times larger than in the low cost variant, whereas the collector and ground store costs are about 1.5 higher than those in the low cost variant).

SUBSYSTEM COST – HIGH COST VARIANT	Parameter value
Solar collectors	900 CHF/m²
Buffer store	3'000 CHF/m³
Ground store (correspond to 187 CHF/m ³ with a store volume of 8'000 m ³ and a total pipe length of 28'600 m)	169 CHF/m³ + 5 CHF/m

Parameter variation simulated

The scaling factor for the parameter variation is the collector area. Additional system simulations were performed to find out optimal parameter values for the high cost variant. They are systems having a buffer store volume of 20 and 40 litre/m², and a ground store volume of 3 m³/m².

Low cost variant

Heumatt with Soltop collector , 986 MWh/y (67% space heating and 33% domestic hot water)

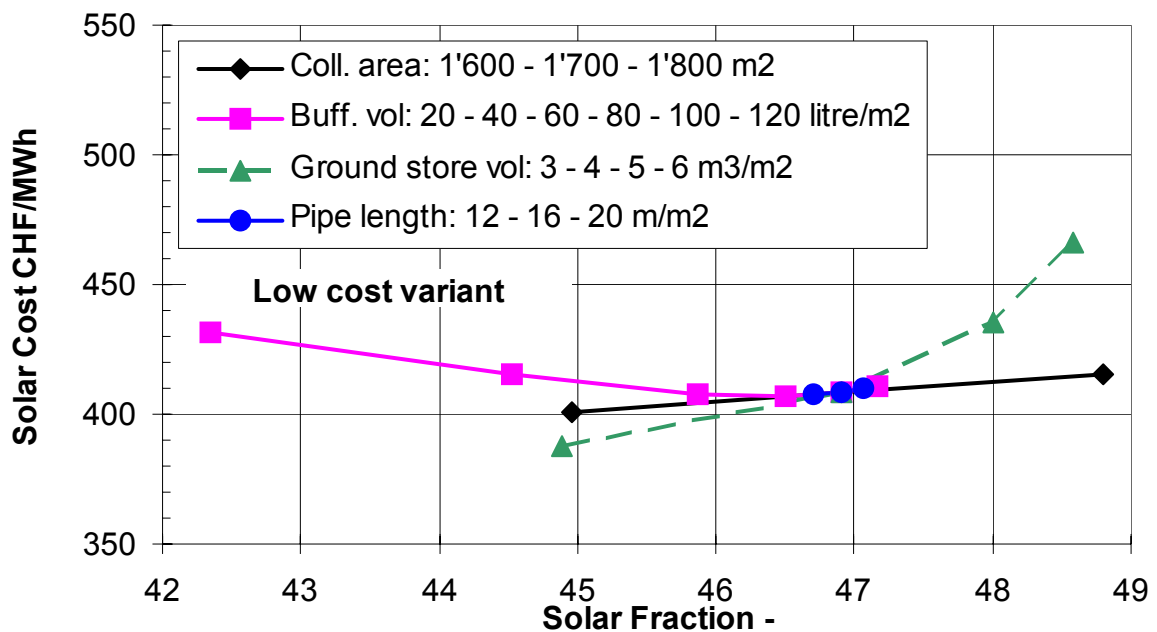

Figure 6.12: Parameter curves in the diagram “solar cost” – “solar fraction” for the low cost variant.

High cost variant

Heumatt with Soltop collector , 986 MWh/y (67% space heating and 33% domestic hot water)

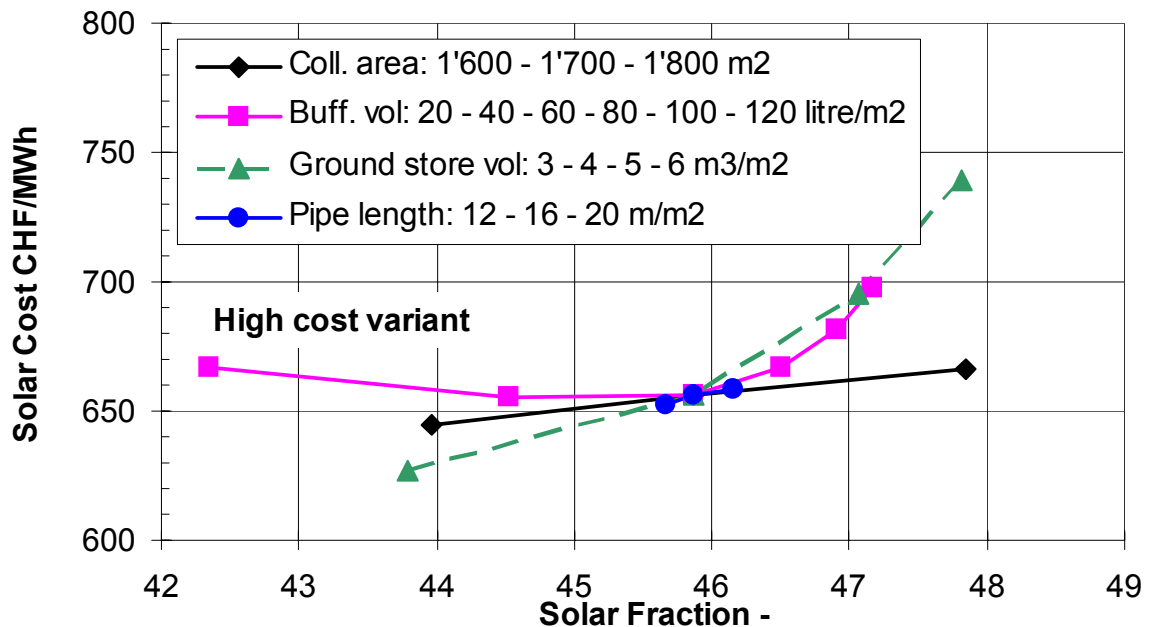

Figure 6.13: Parameter curves in the diagram “solar cost” – “solar fraction” for the high cost variant.

Due to the relatively higher buffer store cost, the optimal buffer store volume is smaller than that for the low cost variant: 60 litre/m² instead of 100 litre/m². As a result, taking into account the costs variations, an optimal buffer store volume would lie between **60 to 100 litre/m²**.

A smaller ground store volume (3 m³/m²) would still make a slightly lower solar cost, but would create overheating problems in the collector field. The sensitivity to the pipe length is also weak. Setting 16m/m² for the pipe length, the pipe length optimisation has a second order influence both on the solar cost and the solar fraction.

SENSITIVITY TO THE TYPE OF COLLECTOR

Another type of flat plate collector has been simulated. The main differences are summarised in the following table, including the change in the solar fraction.

Collector average transmittance-absorptance product	0.805 -	(-3%)
Collector overall loss coefficient (for ΔT = 40 K)	4.46 W/m ² K	(+10%)
Solar fraction	42.2%	(-10%)

SENSITIVITY TO THE RETURN FLUID TEMPERATURE OF THE HEAT DISTRIBUTION

The return fluid temperature is also an important parameter. A simulation with a return fluid temperature in the space heating distribution network of **28 °C instead of 35 °C at -8°C** outside showed that the solar fraction was increased by about 5%. It was equivalent to about **200 m² of additional collectors** (increase of 10% of the collector area).

7. References

D. PAHUD (1995) Development of System Simulation Tools of Central Solar Heating Plants with a Seasonal Duct Store in The Ground. Department of Mathematical Physics, Lund Institute of Technology, Lund, Sweden.

D. PAHUD (1996) Simulation of Central Solar Heating Plants Using a Duct Store: an Application for Switzerland. Swiss grant Nr: 8220 – 042846. Department of Mathematical Physics, Lund Institute of Technology, Lund, Sweden.

D. PAHUD (1998) Simulation dynamique en régime transitoire de systèmes de chauffage solaires avec stockage saisonnier de chaleur dans le terrain, rapport intermédiaire de juin 1998, EPFL - LASSEN, Switzerland.

D. PAHUD (1999) Central Solar Plant with a Seasonal Duct Storage. Dynamic Thermal Simulations of the Overall System, intermediate report E1 to the final report E Gesamtsystemoptimierung, septembre 1999, EPFL - LASSEN, Switzerland.

W. DUBACH, H. FUCHS, P. HARTMANN, H. JUZI, H. WANNER, R. WELLAUER and D. PAHUD (1999) Saisonale Speicherung von Sonnenenergie im Erdboden zur Wärmeversorgung von grösseren Überbauungen. Schlussbericht, BFE-Project 18'543, Bern, Schweiz.

P. HARTMANN, H. JUZI, W. DUBACH, H. FUCHS, H. WANNER, R. WELLAUER and D. PAHUD (2000) Sommersonne für den Winter speichern – ein Traum ? Schweizer Ingenieur und Architekt n°14, 7.4.2000, pp. 304 – 308.

D. PAHUD (2000) Central Solar Heating Plants with Seasonal Duct Store and Short Term Water Store: Design Guidelines Obtained by Dynamic System Simulations. Solar Energy, Elsevier Science Ltd, Vol. 69, No 6, pp. 495-509.