

Capacity Building for Solar Thermal Energy in India

Rangan Banerjee

Department of Energy Science and Engineering

IIT Bombay





Solar Thermal

- Fossil fuel reserves finite
- Motivation for energy conservation – Cost Reduction, Emission reduction, Mitigating Climate change
- Solar -High Initial capital cost, Low operating cost
- Solar – No resource constraint, but variable supply, need for storage
- Technology development, R&D – cost reductions
- Future energy systems – different rules – new skill set
- Solar Mission – Thrust on solar



Renewable Energy Options

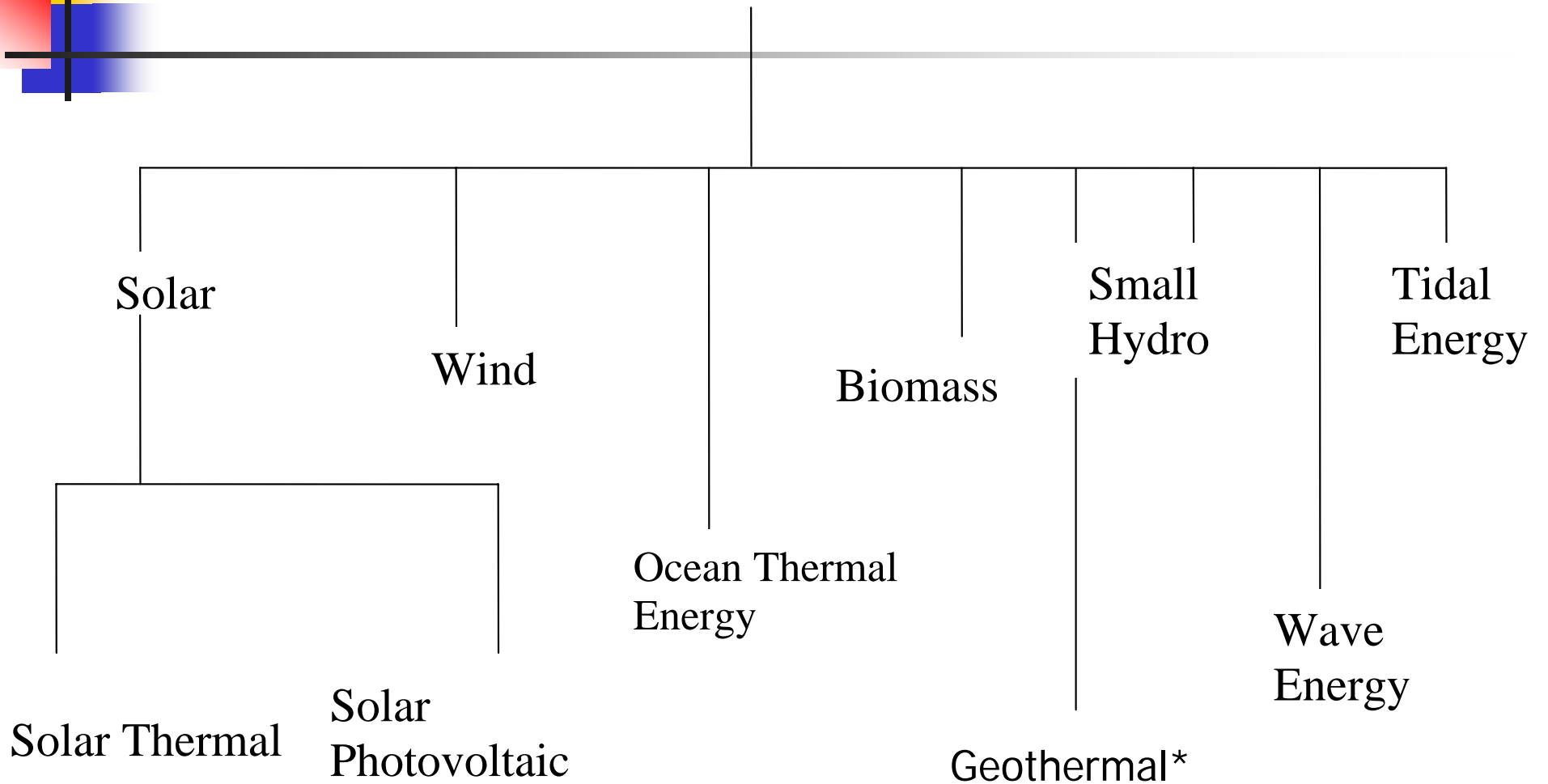

End Uses and Technologies for Use of Solar Energy

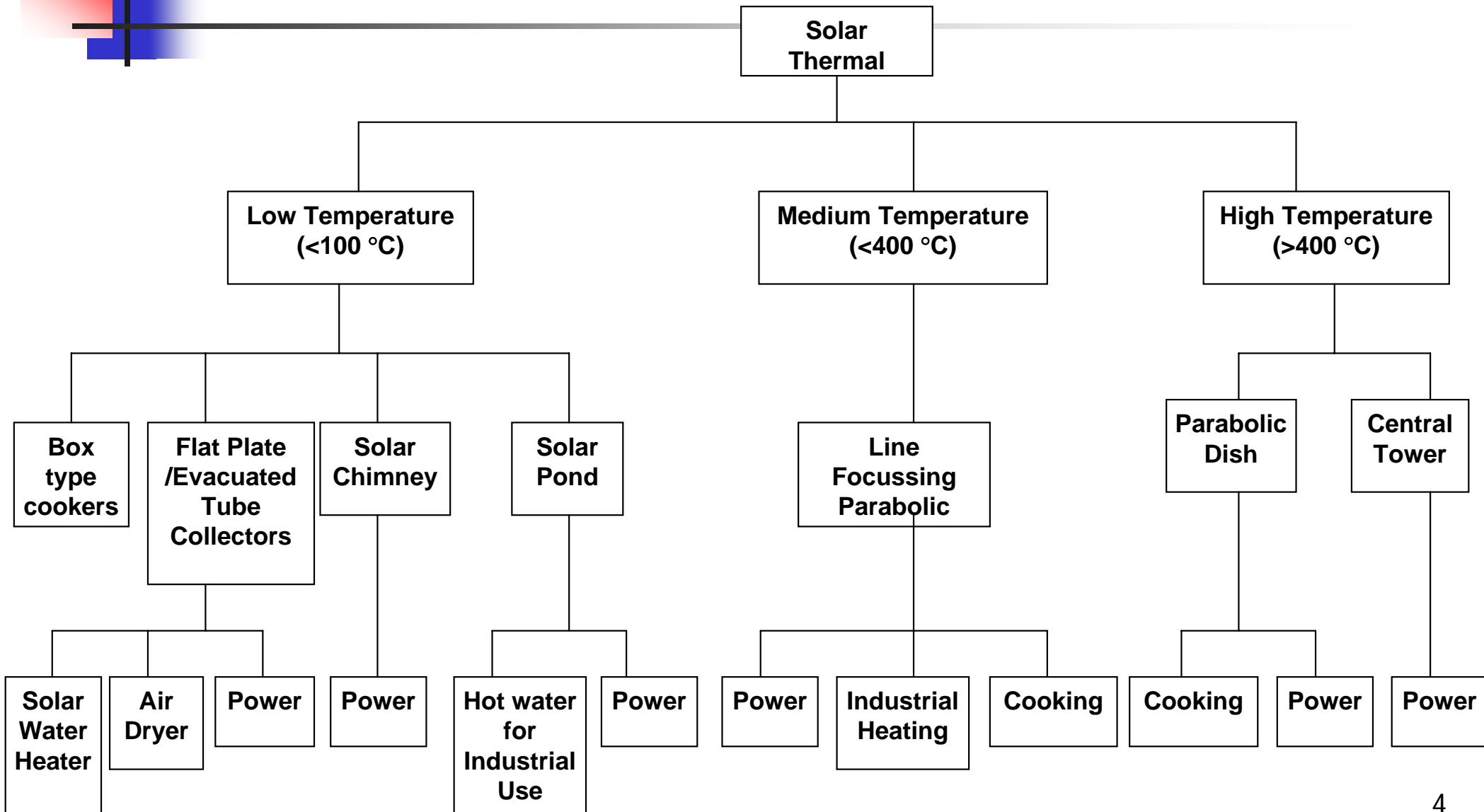

Solar Thermal



Arun

ARUN160 at Mahananda Dairy, Latur

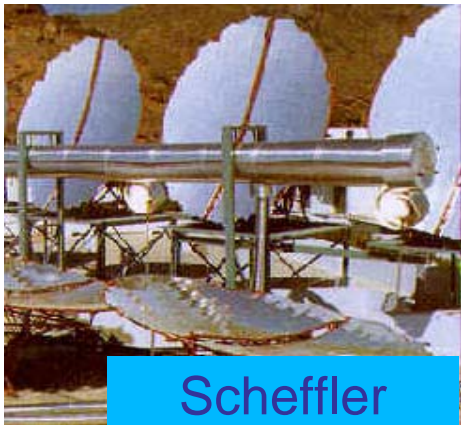

Scheffler

- Solar Thermal for air drying, process heating
- MW Scale Plant – National testing, research facility
- Largest Solar cooking facility in world
- Selective Coatings
- Stirling Engine
- Steady state and Dynamic Testing
- Optimal system sizing and potential estimation



Evacuated glass tube solar air heater



Test Facility for thermosyphon systems

Solar Passive

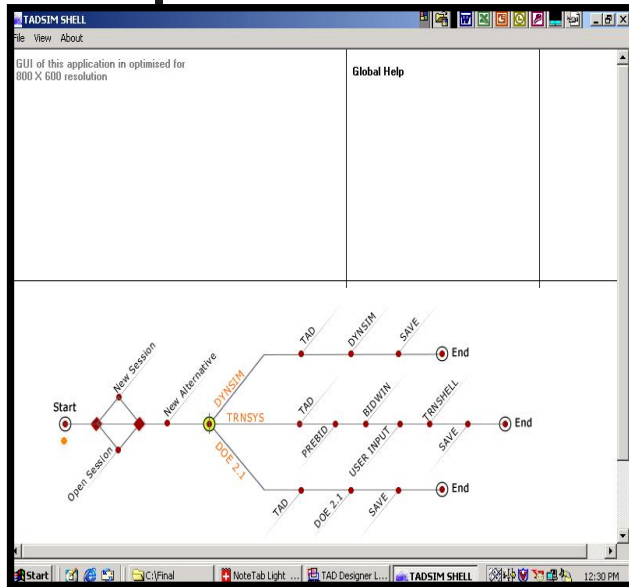

Software Tool for Building Energy Analysis (J K Nayak,ESE)



'South facing Trombe Wall of Storage Unit' (S B Kedare,ESE)

Research Outputs

- **Tools for architectural design & simulation- Interface for architects to assess energy performance of buildings - disseminated to architects**
- **Storage room with 'Trombe wall' - constructed at "Madhura Honey", Gwalior**
- **Retrofit for day-lighting in faculty office**
- **Handbook – Solar Passive**



Day light retrofit (C S Solanki, ESE)

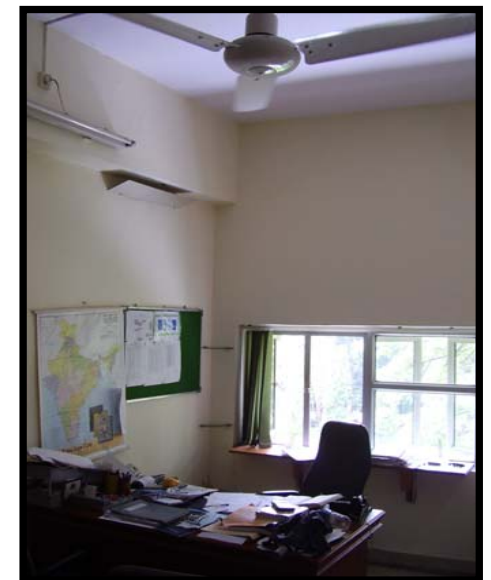

Cooking with the Sun Concentrators



live.pege.org



Balcony system
(Dhule: Ajay Chandak)

Solar Cooking



<http://gadhia-solar.com/images/steamsystem.jpg>

Details of world's largest solar steam cooking system

1.	Location of world's largest solar steam cooking system	Tirupati in Andhra Pradesh (2002)
2.	Capacity	15,000 people (two meals/day)
3.	Cost of system including back up boiler, utensils and AMC for 5 years	Rs. 10.9 million
4.	Generation	4000 kg. of steam/day at 180°C and 10 kg.cm²
5.	No. of concentrators	106 automatic tracked parabolic concentrators of 9.2 m² reflector area
6.	Savings	around 1,18,000 diesel per year

Sample Research projects approved by MNRE

Project Title	Organisation
Small Electro-chromic window	National Physical Laboratory, New Delhi
Solar Distillation of Aromatic grassess and other plant materials	RRL, Bhubneshwar
Polymeric materials for low temperature solar thermal applications	University of Jaipur, Jaipur
Large scale concentrating solar collector for medium temperature	IIT Bombay, Mumbai
Assessment of solar drying in the Hilly regions of Uttaranchal	Department of Physics H.N.B. Garhwal University, Srinagar, Uttaranchal
Development of 16 meter square parabolic dish	World Renewable Spiritual Trust, Mumbai
Combined solar and wind induced enhanced ventilation system	Malviya National Institute of Technology, Jaipur
Development of test procedure for solar concentrators and its implementation on two types of dish concentrators	IIT Bombay, Mumbai
Solar food processing products for quality assurance at Hyderabad	Society for Energy, Environment and Energy (SEED), Hyderabad
Development, testing and evaluation of Tubular skylights for passive day lighting of Indian Manufacture	Sardar Patel College of Engineering, Andheri, Mumbai
Solar drying technologies for drying industrial products	College of Technology & Engineering, Maharana Pratap Univ. of Agriculture and Technology, Udaipur

Status Solar Thermal

	Industry	R&D status	Needs
Solar Water Heating	Commercial large number of small players	Less experience on ETC	Improved design and sizing capabilities
Solar Passive	Limited experience	Research groups, ECBC, TERI Griha	Training of architects, consultants, assess performance of building
Solar Cooking	Community cooking – few suppliers	Testing protocols developed	Need for thermal storage research, innovative designs, need for popularisation
Solar industrial heating	Low grade heat – boiler feed water, steam	CLFR, parabolic, dish	Need for testing protocol, need for cost reduction
Solar Power	Few demonstrations being attempted, large number of projects being announced	Sub-critical, growing interest in industry and academia	Need for consortium long terms approaches, prototypes
Solar cooling, distillation, drying	Limited experience	Individual projects, sub-critical	Innovative approaches, goal oriented research, cost reduction

Model for Potential Estimation of Target Area

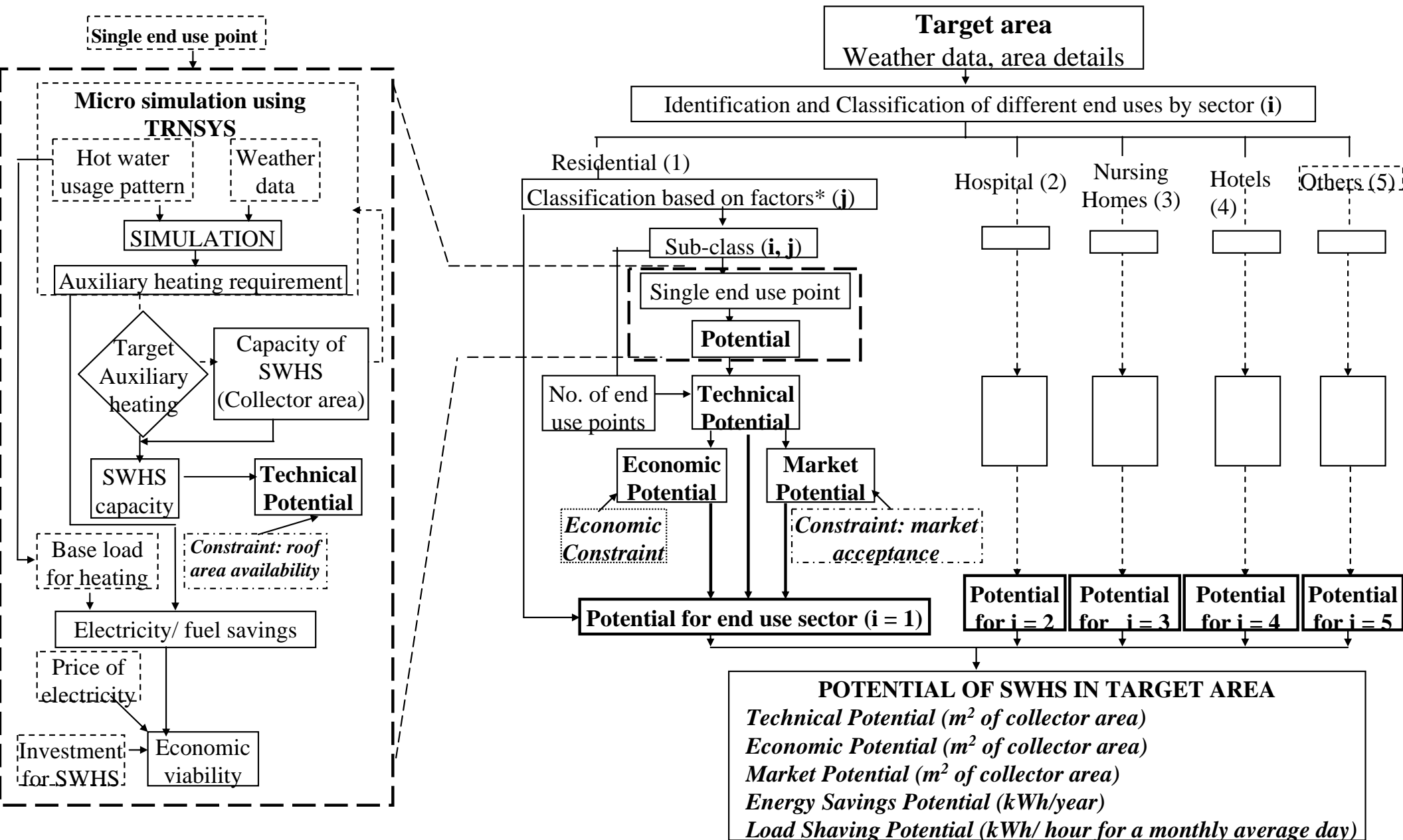

* Factors affecting the adoption/sizing of solar water heating systems

Load Curve Representing Energy Requirement for Water Heating

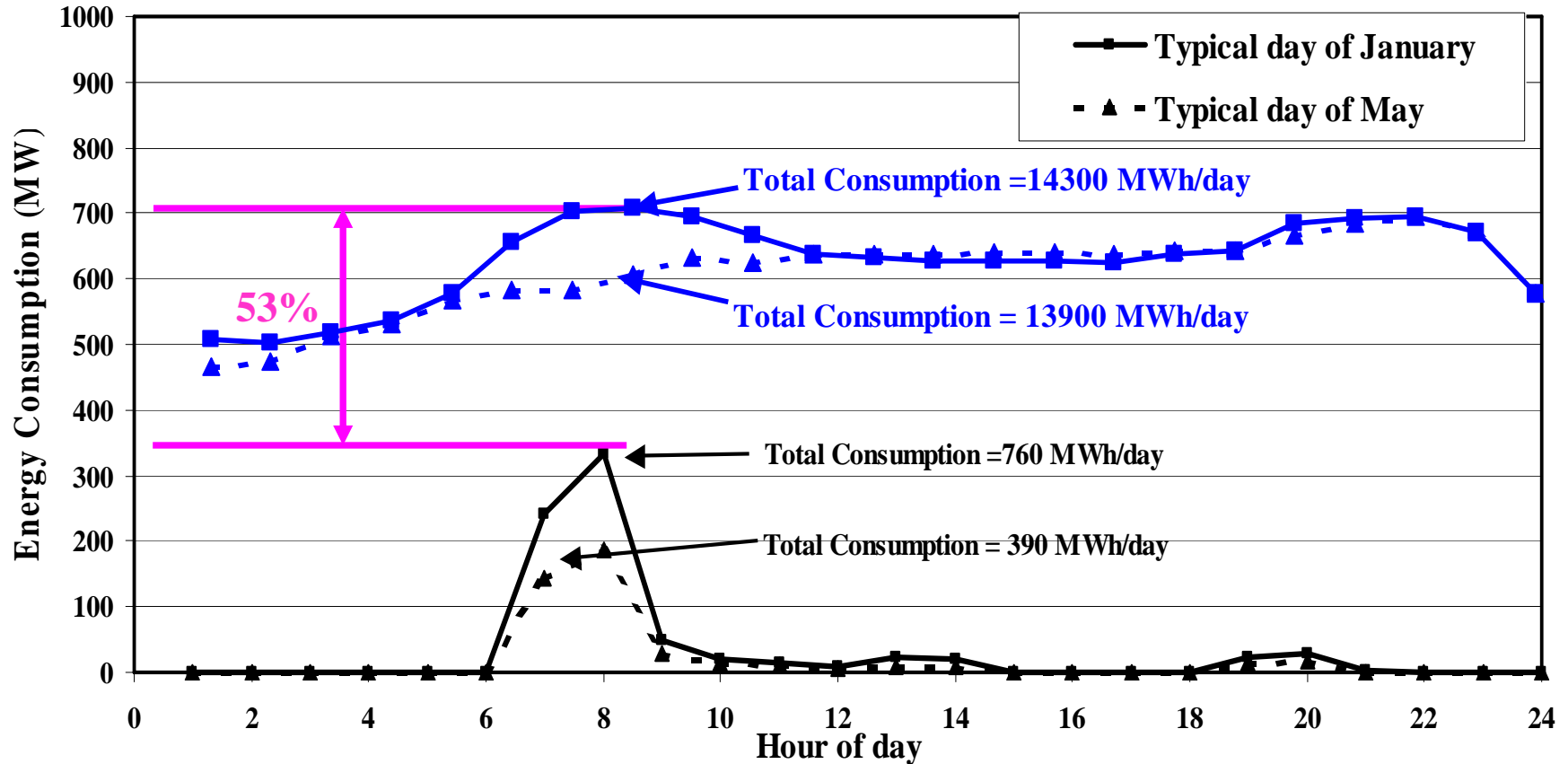

■ *Total Electricity Consumption of Pune*

■ *Electricity Consumption for water heating of Pune*

Diffusion of SWH

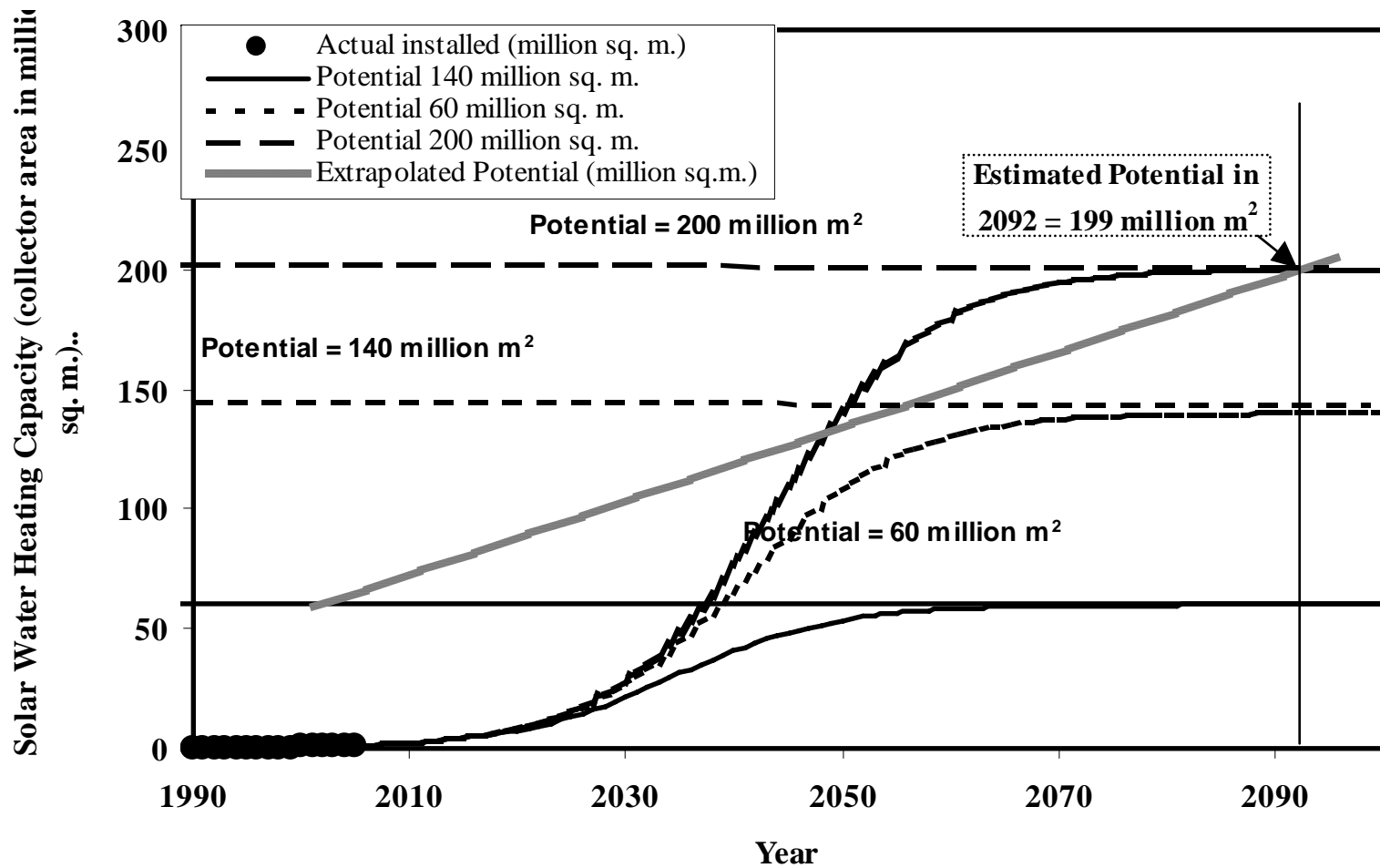

Functional Areas -Renewables

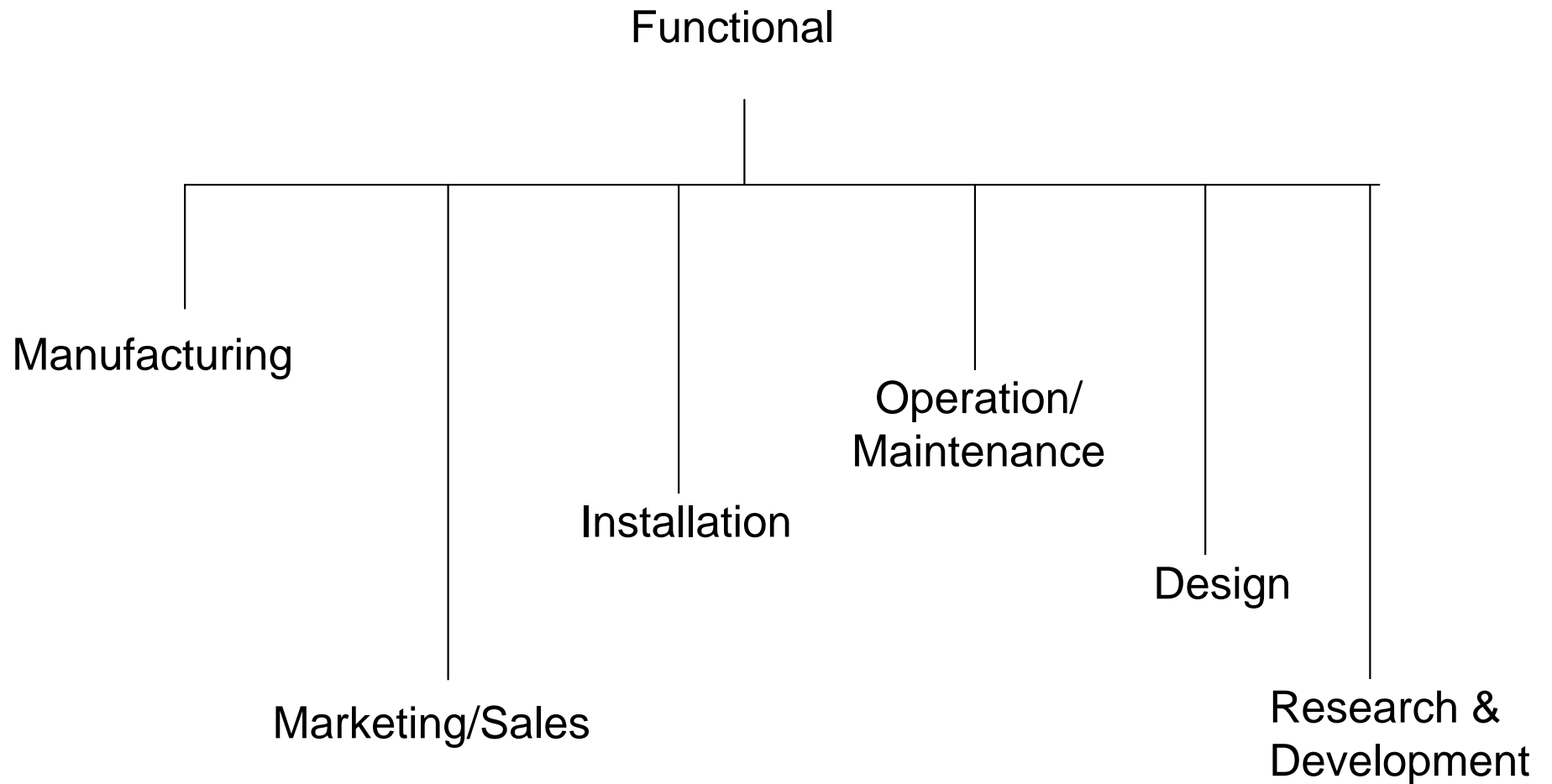

Renewable Energy Institutions

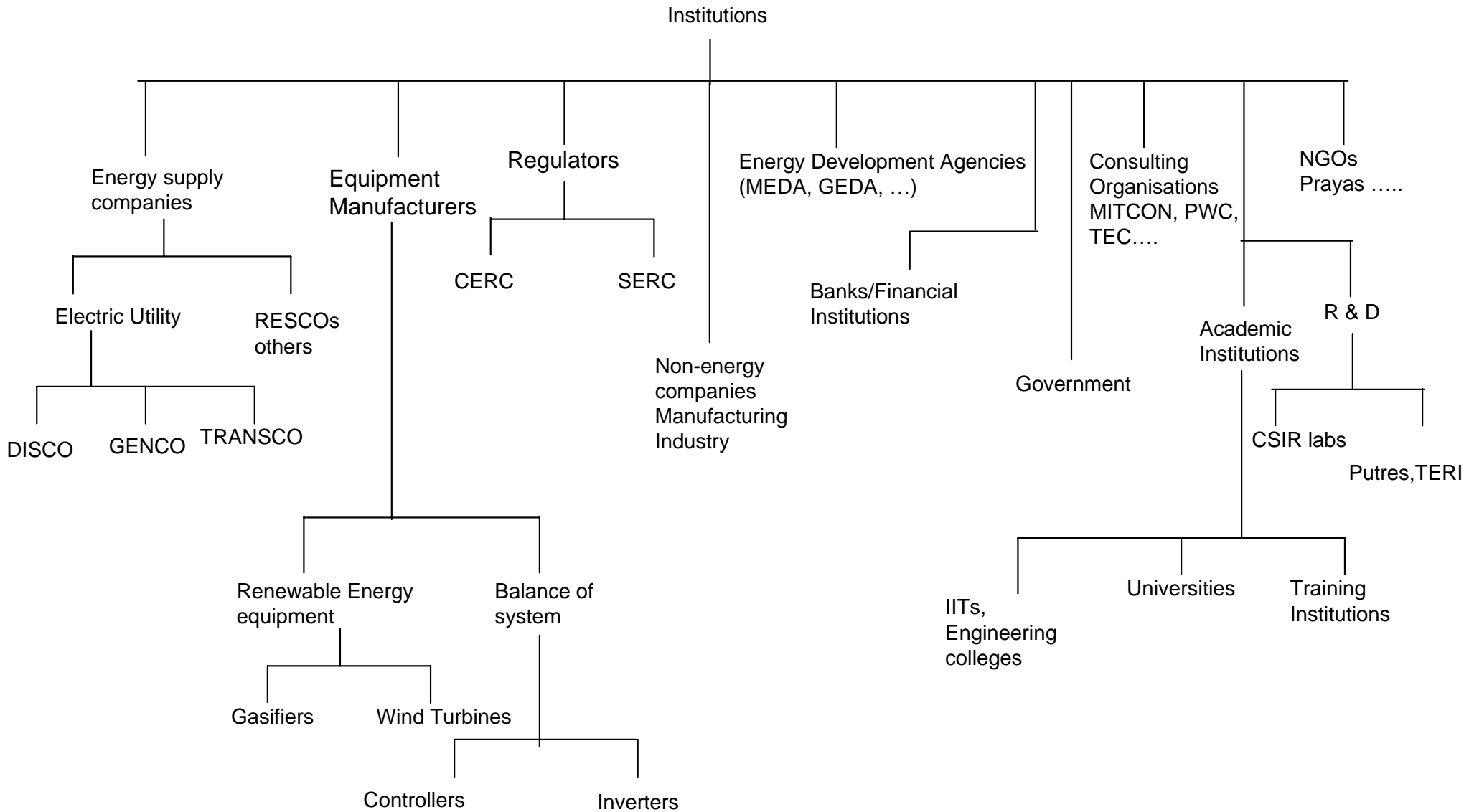

Classification of Training Levels

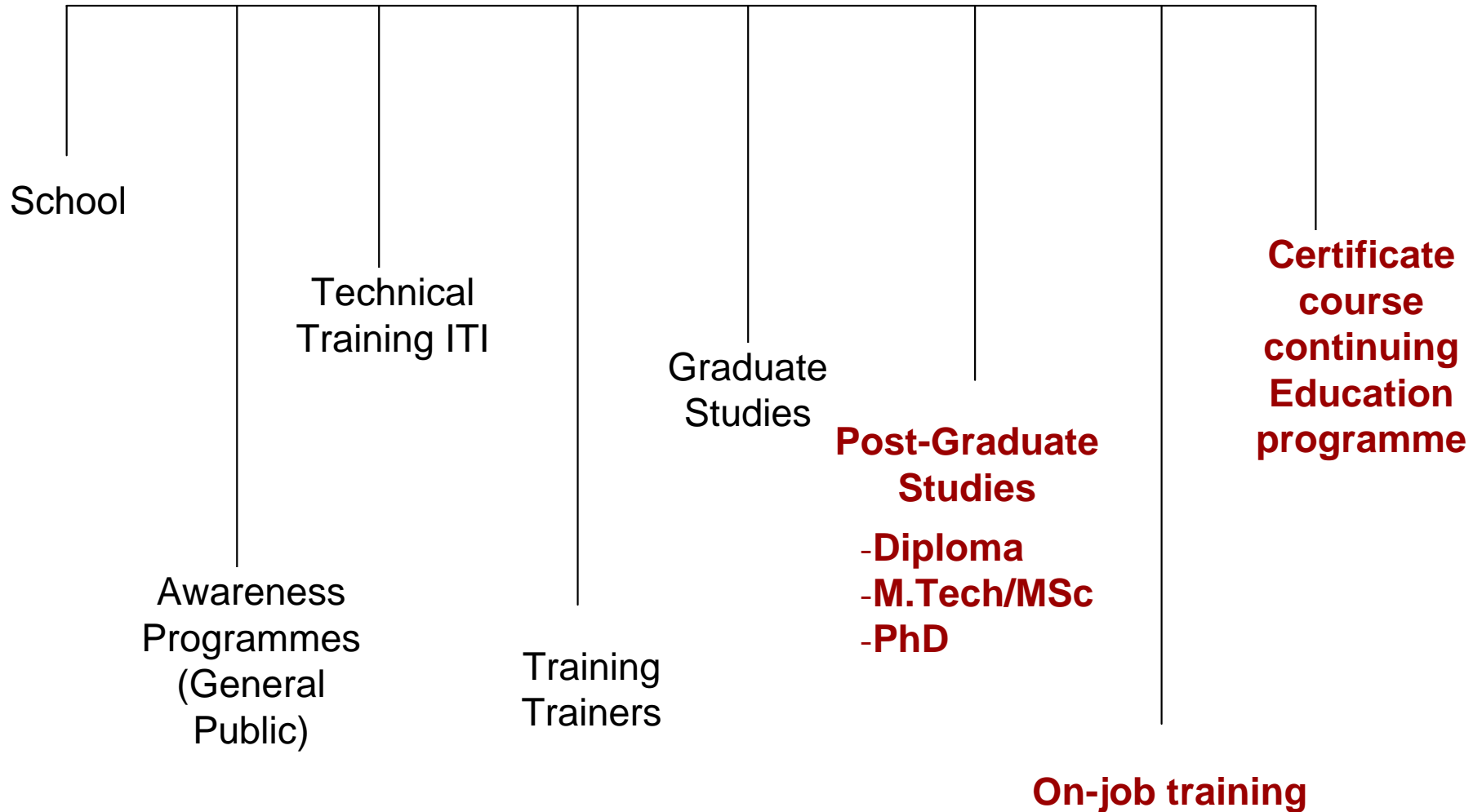

List of core courses

Course code / name	Institute / College
EN 630-Utilization of Solar Thermal Energy	Department of Energy Science & Engg., IIT Bombay
EN 619 Solar Energy for Industrial Process Heat	Department of Energy Science & Engg., IIT Bombay
EN 612 Non-conventional Energy Systems Lab	Department of Energy Science & Engg., IIT Bombay
ESL 840 Solar Architecture	Centre for Energy Studies, IIT Delhi
ESL 850 Solar Refrigeration and Airconditioning	Centre for Energy Studies, IIT Delhi
ESL 770 Solar Energy Utilization	Centre for Energy Studies, IIT Delhi
YRE107 - SOLAR ENERGY LAB	Periyar Maniammai University
YRE 103 - SOLAR ENERGY ENGINEERING	Periyar Maniammai University
Energy Conversion Systems	Faculty of Engineering & Technology, Jadavpur University
Solar Thermal Energy Systems	Faculty of Engineering & Technology, Jadavpur University

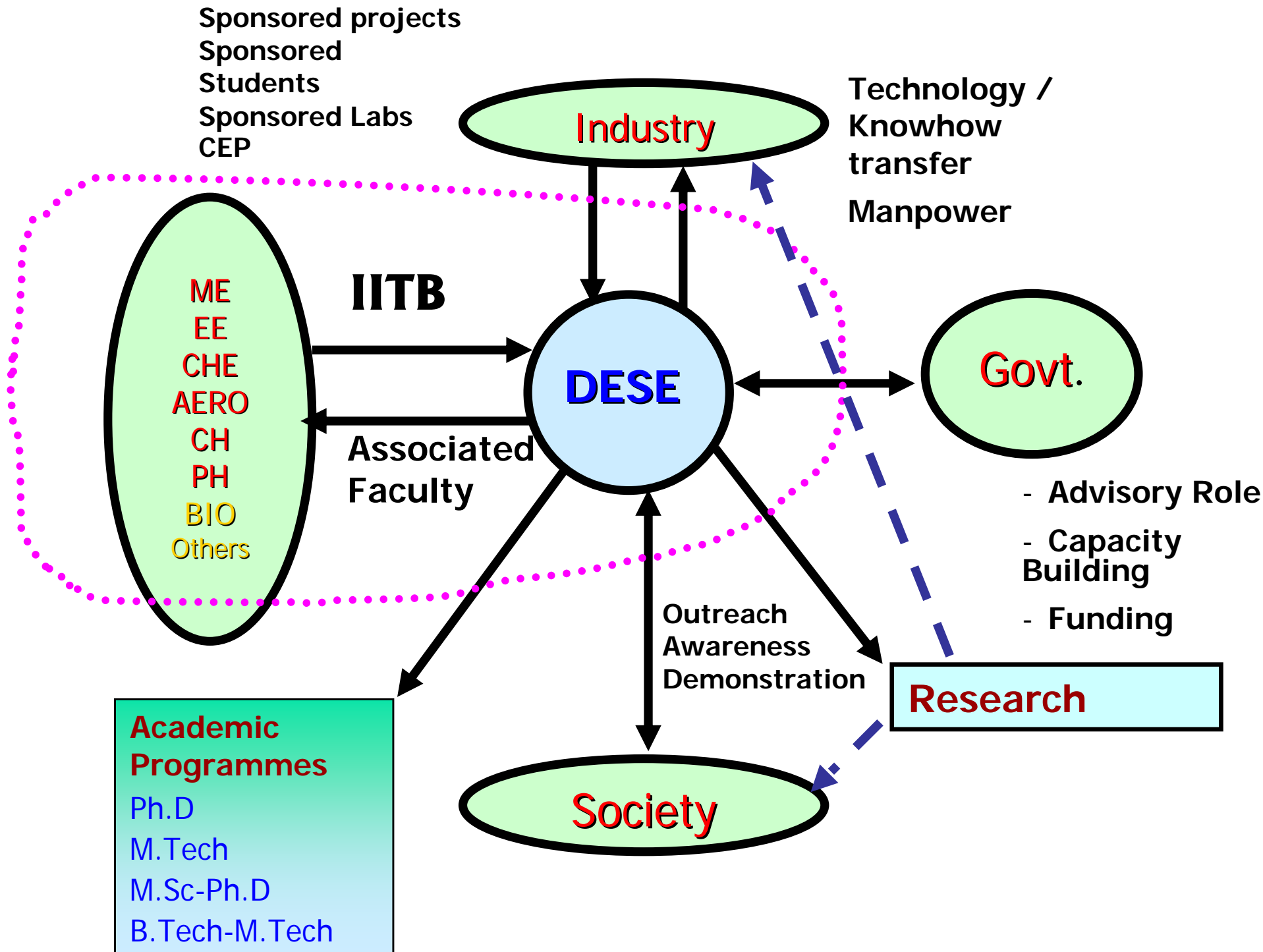



Academic Programmes

- M.Tech in Energy Systems Engineering(25- 30)
- PhD (3-5)
- Dual Degree -MSc- PhD (started from 2007) Batch of 12
- Dual Degree- B.Tech in Energy Engineering
M.Tech in Energy Systems Engineering (started from 2008) Batch of 22 (Five year programme)
- Minor in Energy Engineering for B.Tech students

Challenges for Solar Power

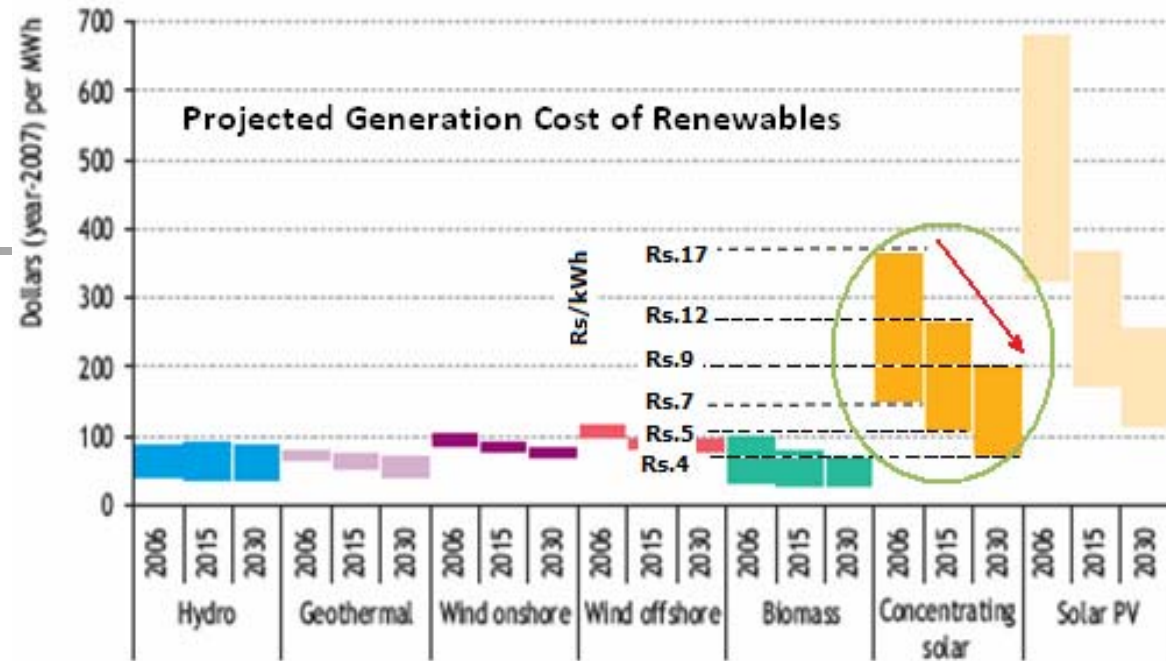
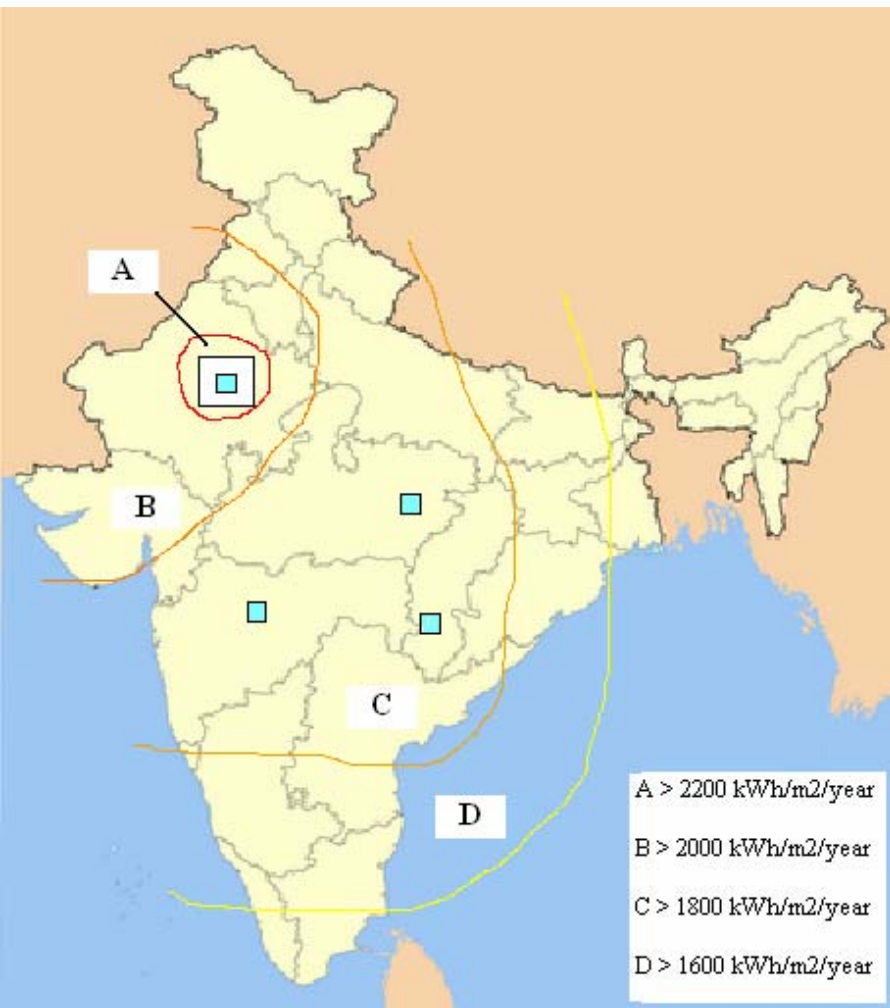

Source: World Energy Outlook – 2008, International Energy Agency

Solar Insolation and area required

- = 2500 sq.km
- = 625 sq.km

1. Limited experience in CSP in the country
2. Need for cost reduction
3. Need for indigenous technology, system development
4. Need for demonstration, public domain information

Concept/Objectives

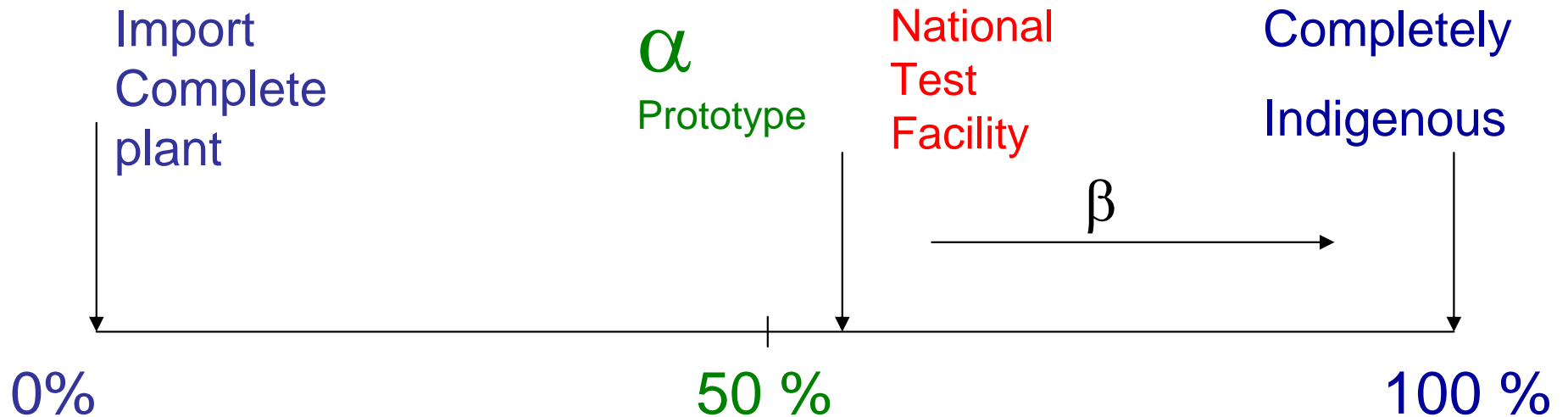

- **1MW Solar Thermal Power Plant**
 - Design & Development of a 1 MW plant.
 - Generation of Electricity for supply to the grid.
 - Development of technologies for component and system cost reduction.
- **National Test Facility**
 - Development of facility for component testing and characterization.
 - Scope of experimentation for the continuous development of technologies.
- **Development of Simulation Package**
 - Simulation software for scale-up and testing.
 - Compatibility for various solar applications.

Proposed Schematic

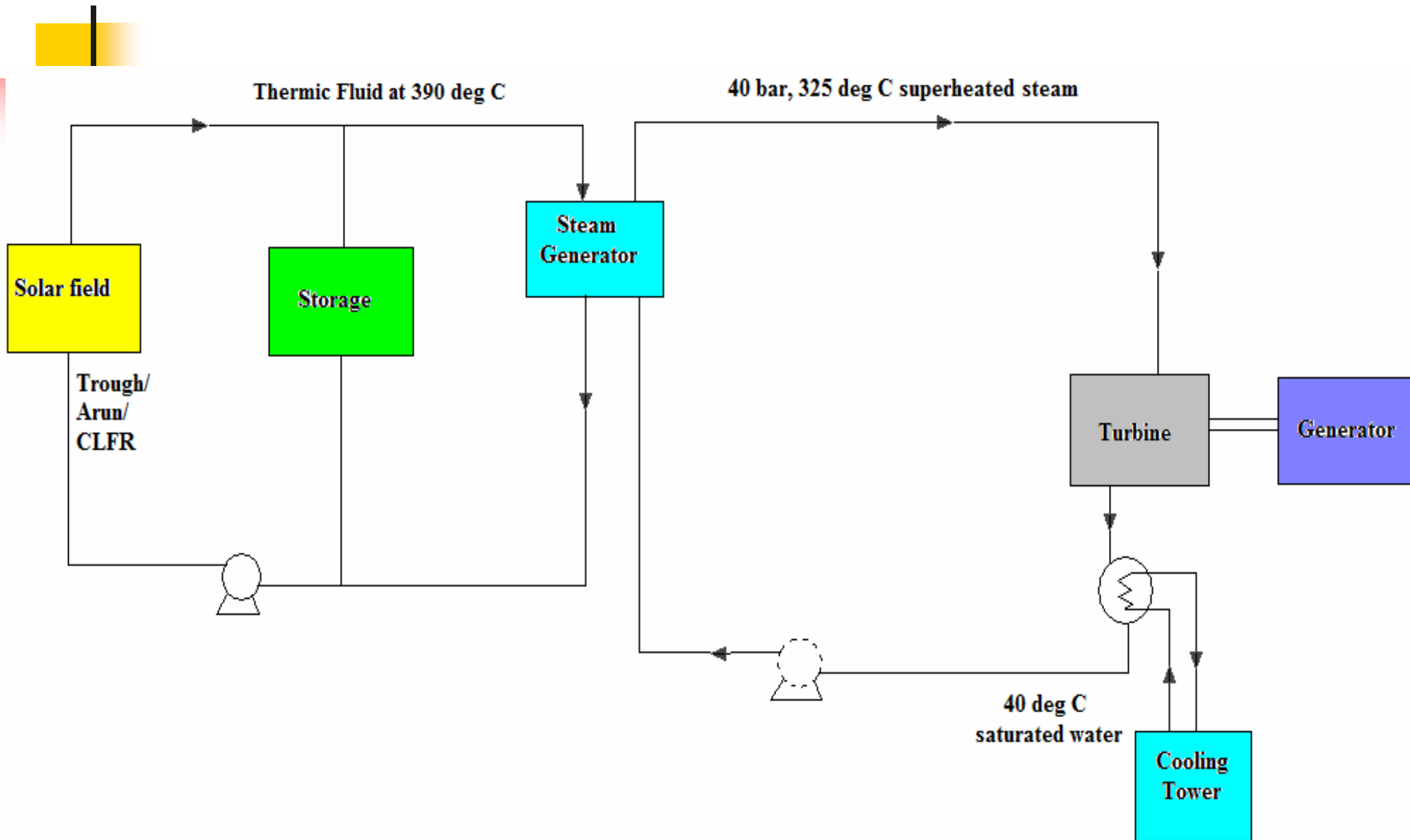

Solar Field Components



Arun Technology



CLFR Technology

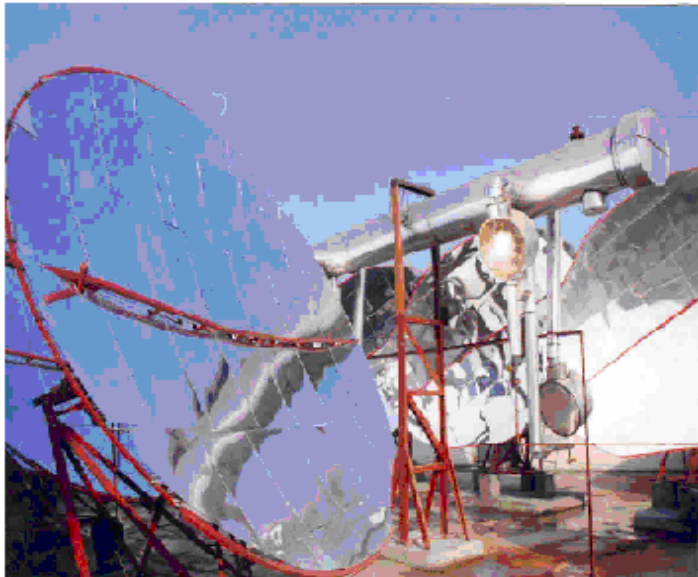

Scheffler paraboloid dish



Parabolic Trough

Consortium Members



Lead the consortium for the development of a 1 MWe grid connected solar thermal power plant, testing facility and simulation facility.



SOLAR ENERGY CENTRE

Providing sit for installation of the 1Mw solar thermal power plant and the test facility at Gwalpahari, Gurgoan



Design engineering.



LARSEN & TOUBRO

It's all about Imagineering

Design, fabrication, installation, performance monitoring and analysis of heat exchangers.

KIE Solatherm

Design, supply and installation of parabolic trough concentrators / distribute mirror concentrators



TATA POWER

Operation and maintenance of power plant during the project period, support for installation and commissioning



Supply, installation and commissioning of required ARUN Solar Thermal Concentrators and / or other solar concentrators.

Functioning Mode

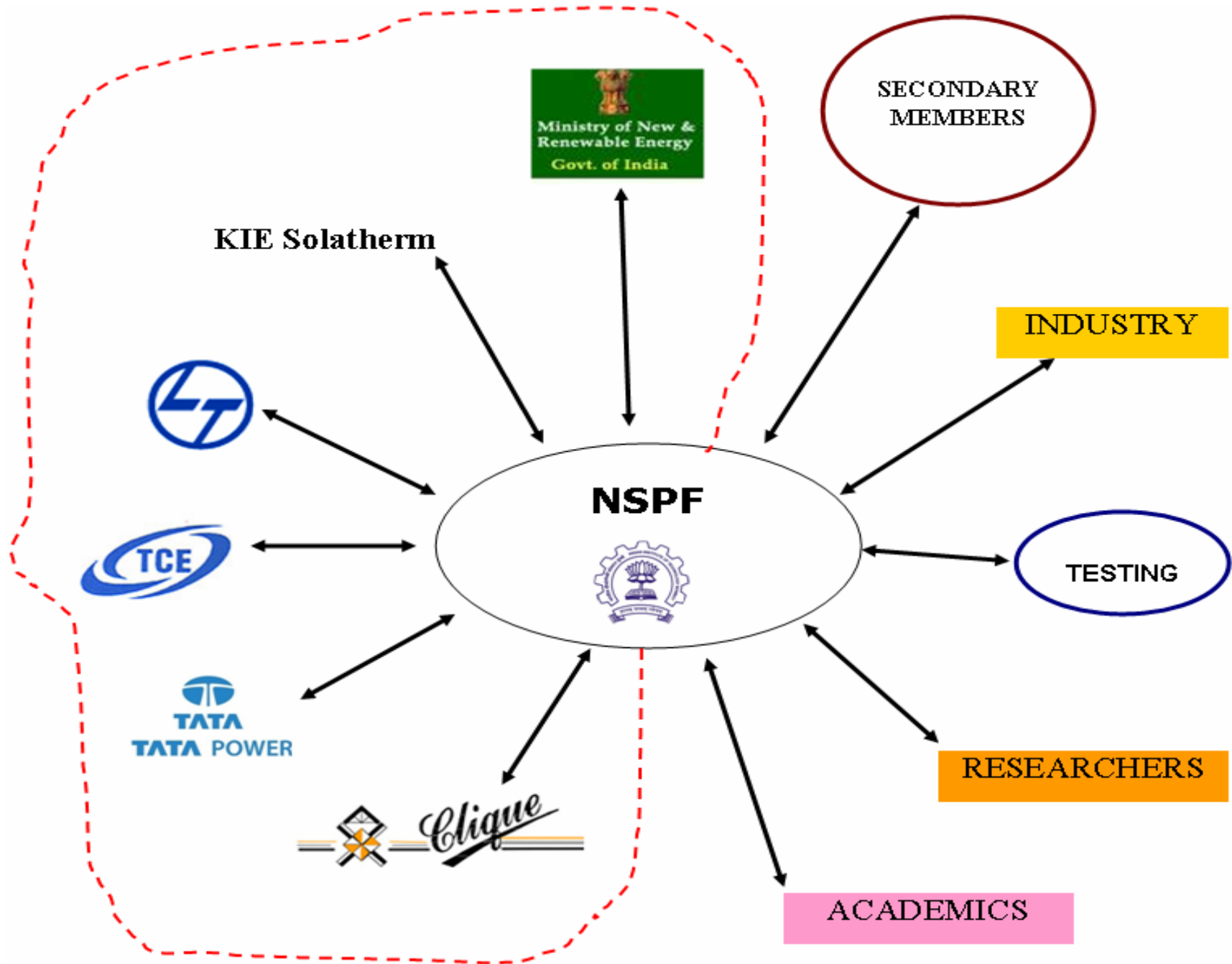



Making it happen

- People – Attracting best people from traditional domains
- Research “ Grand challenge”
- Directed research – “ Mission”
- Reality check – benchmarking performance and achievements
- Competence building – education and research



Capacity Building

- Training for maintenance – Technicians (ITI)
- Improving sizing and design capabilities
- Testing protocols
- Areas – Materials, optics, coatings, heat transfer, fluid flow, solar radiation, controls, tracking
- Manufacturing for improved performance and reduced cost
- Solar passive – Integration into building designs
- Tracking and monitoring performance and establishing feasible targets



References

- Green Jobs: Towards Decent Work in a Sustainable, Low-Carbon World, UNEP/ILO/IOE/ITUC, September 2008.
- Banerjee R., 'Advanced Training for Renewable Energy Professionals in India', Proceedings of the Intl. Congress on Renewable Energy (ICORE 2006), February 2006, Hyderabad.
- Banerjee R., 'Capacity Building for Renewable Energy in India', Proceedings of the Intl. Congress on Renewable Energy (ICORE 2005), January 2005, pp 77-83, Pune.
- Indu R. Pillai and R. Banerjee, 'Methodology for estimation of potential for solar water heating in a target area', Solar Energy, Vol.8, No.2, pp 162-17, 2007.
- http://www.ese.iitb.ac.in/academics/mtech_index.html#courses
- <http://gadhia-solar.com/images/steamsystem.jpg>
- <http://live.pege.org>
- <http://mnes.nic.in/list/solar-th-rdprojects.pdf>

Email: rangan@iitb.ac.in

Thank you